

Varosa II

T Grid Lighting Solutions for

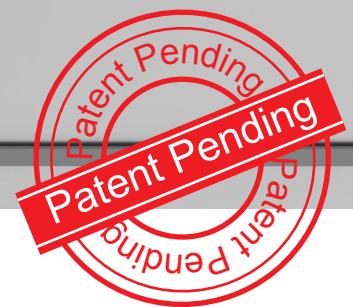

Varosa is an innovative lighting solution to work on 15mm and 24mm T grid ceiling system. While UGR is rated as low as 16 (Black reflector), it can achieve over 105lms/W. With its patent pending hanging structure, Arosa can be linked smoothly from one to another to create better ceiling image.

Varosa II An innovative lighting product solution for T-Grid suspension ceilings.

Varosa T Grid Lighting Solution Product Options:

Varosa II-B



Varosa II-P



Varosa II-W

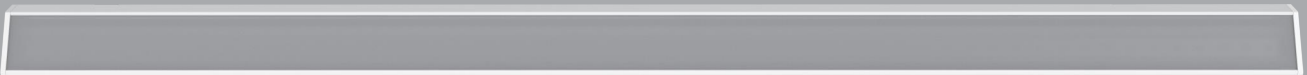

Standard Lens Beam Angle 90° , optional 30° and 60° .

Standard Length: 600mm and 1200mm.

Other length available by request.

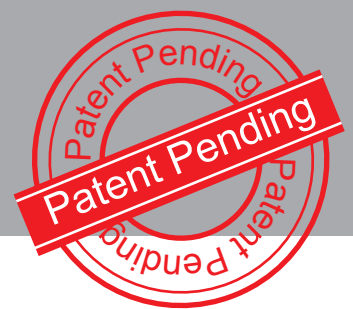

Arosa range can work with different tile edges on 15 and 24mm T bars.

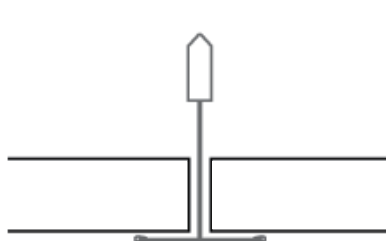

**SQUARE
EDGE**

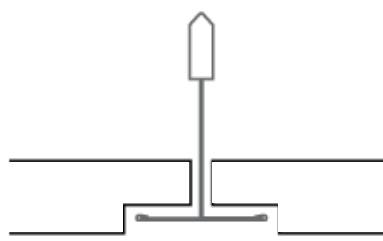

**TEGULAR
EDGE**

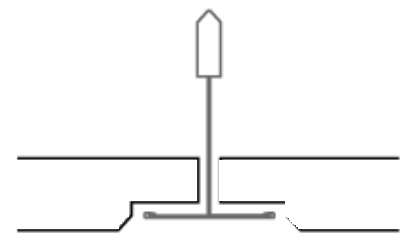

**BEVELED TEGULAR
EDGE**

Varosa II An innovative lighting product solution for T-Grid suspension ceilings.

Remarkable Installation Savings

Up 60% faster installation

Over 40% material cost saving

Installation steps:

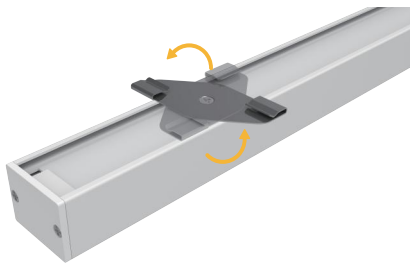

1. Move the hanger toward to the end cap as much as possible and turn the hanger vertically to the light fitting.

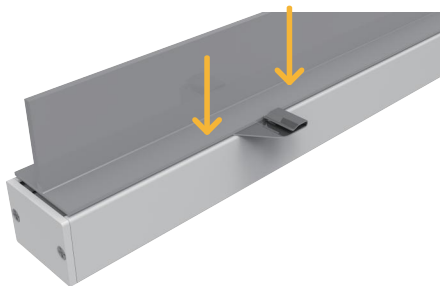

3. Place Arosa under the T bar closely.

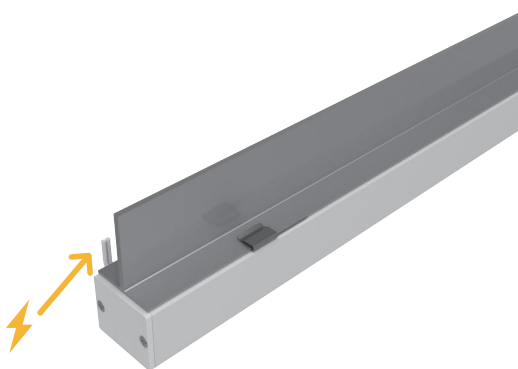

5. Place the Low Voltage cable alongside the T bar and connect to DC 48V power Supply.



7. Now the installation is completed.

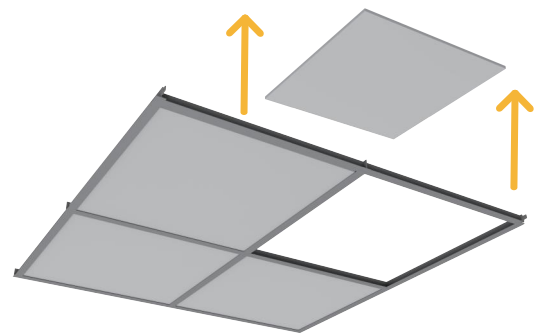

2. Remove the tiles from the T grid for easy installation.



4. Turn the hanger clockwise and lock the hanger to the T bars.

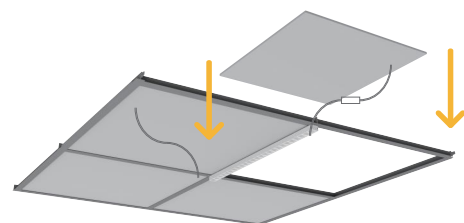

6. Place the tiles back to the ceiling.

Varosa II An innovative lighting product solution for T-Grid suspension ceilings.

Varosa II B Size (Unit:mm)



AS06-B

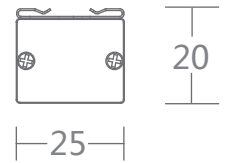
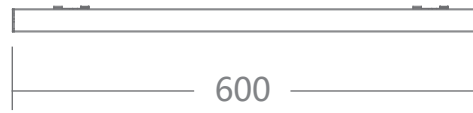

AS12-B



Range	Description	Power(W)	Voltage (V)	Total Flux (lm)	Colour (K)	CRi	CC or CV	Length (mm)	Product Code
T Grid	Arosa 600mm Black Reflector	13	48	1200	3000	80	Constant Voltage	600	AS-06-B13-9M830
T Grid	Arosa 600mm Black Reflector	13	48	1280	4000	80	Constant Voltage	600	AS-06-B13-9M840
T Grid	Arosa 1200mm Black Reflector	26	48	2400	3000	80	Constant Voltage	1200	AS-12-B13-9M830
T Grid	Arosa 1200mm Black Reflector	26	48	2600	4000	80	Constant Voltage	1200	AS-12-B13-9M840

Other Colour Temperature available, please contact for details.



Varosa II An innovative lighting product solution for T-Grid suspension ceilings.

Varosa II P Size (Unit: mm)



AS06-P

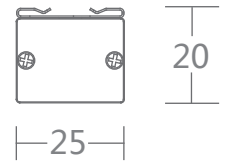

AS12-P



Range	Description	Power(W)	Voltage (V)	Total Flux (lm)	Colour (K)	CRi	CC or CV	Length (mm)	Product Code
T Grid	Arosa 600mm White Reflector	13	48	1300	3000	80	Constant Voltage	600	AS-06-P13-9M830
T Grid	Arosa 600mm White Reflector	13	48	1400	4000	80	Constant Voltage	600	AS-06-P13-9M840
T Grid	Arosa 1200mm White Reflector	26	48	2600	3000	80	Constant Voltage	1200	AS-12-P26-9M830
T Grid	Arosa 1200mm White Reflector	26	48	2800	4000	80	Constant Voltage	1200	AS-12-P26-9M840

Other Colour Temperature available, please contact for details.



Varosa II An innovative lighting product solution for T-Grid suspension ceilings.

Varosa II W Size (Unit: mm)



AS06-W

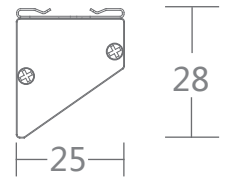

AS12-W



Range	Description	Power(W)	Voltage (V)	Total Flux (lm)	Colour (K)	CRi	CC or CV	Length (mm)	Product Code
T Grid	Arosa 600mm Asymmetric	13	48	1150	3000	80	Constant Voltage	600	AS-06-W13-9M830
T Grid	Arosa 600mm Asymmetric	13	48	1200	4000	80	Constant Voltage	600	AS-06-W13-9M840
T Grid	Arosa 1200mm Asymmetric	26	48	2300	3000	80	Constant Voltage	1200	AS-12-W26-9M830
T Grid	Arosa 1200mm Asymmetric	26	48	2400	4000	80	Constant Voltage	1200	AS-12-W26-9M840

RGB and Other Colour Temperature available, please contact for details.

