

# Floating Air Troffer

## CCT & Wattage Adjustable Version

The indirect LED troffer offers a traditional modern design with the latest lighting technology. Transparent optics engineered specifically for LED sources are integrated with minimalist design and architectural materials to create a broad range of solutions with superior optical and energy performance. High performing optics allows for maximum energy savings and optimal illumination in a ultra-minimalistic shallow recessed fixture, provides a unique translucent appearance without sacrificing performance.

It is architectural recessed lighting solution that compatible for commercial and institutional environments, including office building, medical, health, educational, retail, hotel, airport, hospitality, etc.



### Feature

Available in 2x2 and 2x4 sizes

Transparent Optics

Wattage adjustable, 110lm/w

CCT selectable from 3000K, 3500K and 4000K

Recessed form factor fits most T-grid systems



**US PATENT**  
**US D921,955 S**



### PERFORMANCE

Model NO.	Dimension	Wattage Adjustable	Lumen Output			Efficacy	CCT Adjustable
			High	Medium	Low		
VT22-DM-04W	2'x2'	40W/30W/20W	4400lm	3300lm	2200lm	Up to 110lm/w	3000K/3500K/4000K
VT24-DM-04W	2'x4'	50W/40W/30W	5500lm	4400lm	3300lm	Up to 110lm/w	3000K/3500K/4000K

All efficacy is ±5% base on different CCT and wattage. Check the IES file to gain the accurate data .

# Floating Air Troffer

CCT & Wattage Adjustable Version

## PRODUCT PERFORMANCE

### ▶▶ Optics

It offers unique transparent optics to enhance the fixture aesthetic. fully- uniform transparent optics provide uniform, low-glare illumination for a clean, modern, upgraded look, creating direct and indirect light distribution.



### ▶▶ Construction

Extruded aluminum housing.

### ▶▶ Finish

Powder coat white finish provides uniform finish providing long term performance and superior aesthetic.

### ▶▶ Electrical

**LED Driver** It is powered by Class 2 high efficiency LED driver, with a standard 1-10V dimming which continuous dims to 10% that works with many types of controls. Tested Dimmers: Lutron @ Diva-Dvtv, Leviton @ IP-710-DL.

**THD** <20%

**Power Factor** >0.9

**Input Voltage** Standard electronic drivers are cULus recognized and available for 110-277V or 110-347V\* AC.

### ▶▶ LED System

**CRI** Minimum 80 color rendering index

**CCT** CCT selectable from 3000K, 3500K and 4000K with a great color consistency

**LED** Life Minimum 50,000h with 87.8% of lumen maintenance in 25°C ambient temperature, in compliance with IES LM-80 testing measurements.

**Thermal Management** Aluminum housing acting as the heat sink to maximize life.

**Environment** Damp rated in operating ambient temperatures of -20°C~40°C .

### ▶▶ Mounting

Recessed

### ▶▶ Approvals

- US Patent (US D921,955 S)
- cULus listed for damp locations
- Tested to IESNA LM-79 and LM-80
- DesignLights Consortium Qualified and classified for DLC Standard, refer to [www.designlights.org](http://www.designlights.org) for details
- 5-year Limited Warranty

## PRODUCT ORDERING GUIDE

### Sample

VT 22 - DM - 04 W  
1 2 3 4 5

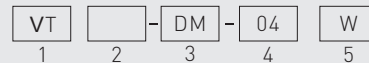

#### 1. Base Model

TT LED Troffer

#### 2. Size

22 2'X2'

24 2'X4'

#### 3. Dimming

DM 1-10V Dimming

#### 4. CCT

04 CCT Selectable 3000K/3500K/4000K

#### 5. Wattage

W Wattage Adjustable

## OPTIONAL ORDERING GUIDE

### Optional Input Voltage

110-277V AC

110-347V AC \*

### Optional Function

LED Emergency Driver (Order Separated)

Sensor \*

\*Additional cost and/or lead time on customized fixtures may apply. Some fixtures require an MOQ. Please contact your sales rep for more information.

# Floating Air Troffer

CCT & Wattage Adjustable Version

## DIMENSION

2x2ft

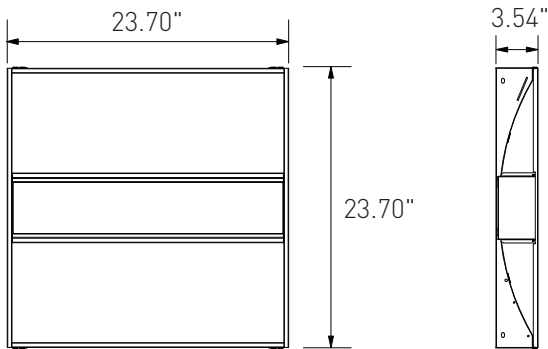

2x4ft

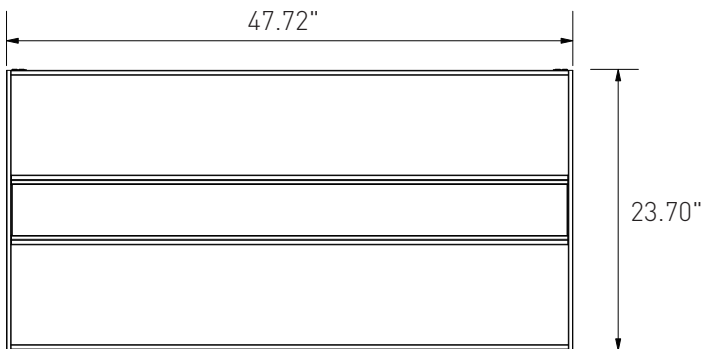

## T-GRIDS CEILING COMPATIBILITY

It is architectural recessed lighting solution that compatible with most 15/16" and 9/16" t-grid systems for commercial and institutional environment. The following are only as some common examples to show.

9/16" Flat



9/16" Slot

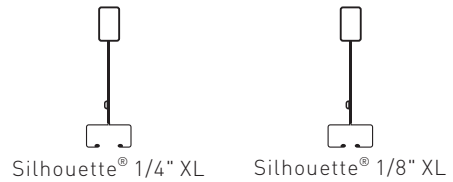

9/16" Interlude

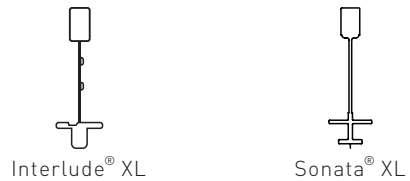

15/16" Flat

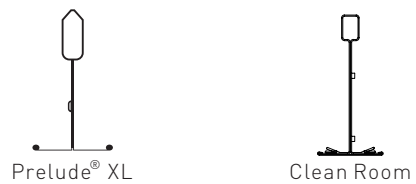

\*Please verify compatibility with factory.

# Floating Air Troffer

CCT & Wattage Adjustable Version

## DISTRIBUTION DIAGRAM

2'x2' / 3500K

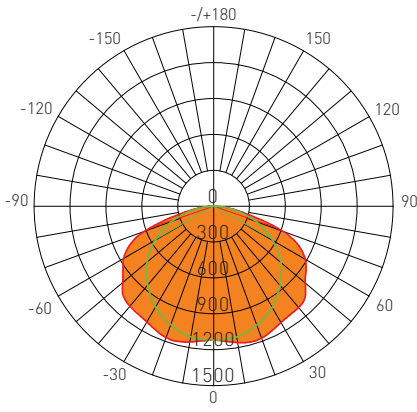

AVERAGE BEAM ANGLE(50%): 131.7°

Test Number: TT22-DM-04W  
 Lumens: 4176.3 Lm  
 Watts: 37.54 W  
 LPW: 111.25 Lm/W  
 CCT: 3500K

UNIT: cd  
 — C0/180,142.4  
 — C90/270,120.9

Zonal Flux Diagram

τ	C0	C45	C90	C135	C180
10	1157	1135	1109	1132	1152
20	1173	1137	1056	1130	1168
30	1124	1084	977.9	1075	1118
40	1105	998.6	863.3	985.1	1090
50	999.8	923.2	733.5	902.0	992.9
60	883.4	772.7	570.2	758.8	868.6
70	615.3	567.1	381.9	552.9	618.6
80	191.9	213.5	168.0	217.0	190.9
90	1.700	1.859	1.366	1.957	2.187
100	2.024	1.918	1.081	1.844	1.101
110	3.018	2.687	1.908	2.654	1.854
120	3.523	2.799	2.082	2.732	1.920
130	3.279	2.414	2.692	2.378	1.938
140	2.295	1.607	2.463	1.499	1.956
150	2.206	0.8639	2.039	0.9721	1.678
160	1.662	0.8615	2.106	1.014	1.721
170	1.850	1.026	2.062	1.154	1.711
180	1.683	1.091	2.463	1.269	1.680
DEG	LUMINOUS INTENSITY:cd				

Zonal Lumens

τ	φ total
0-10	107.6
10-20	428.0
20-30	935.2
30-40	1579
40-50	2310
50-60	3044
60-70	3686
70-80	4070
80-90	4164
90-100	4166
100-110	4168
110-120	4170
120-130	4172
130-140	4174
140-150	4175
150-160	4176
160-170	4176
170-180	4176
DEG	UNIT: lm

Luminance cd/(m2)

G[DEG]	C0/180	C90/270
85	10615	8417
80	11061	9663
75	14172	10589
70	18004	11156
65	18637	11393
60	17682	11393
55	16434	11394
50	15566	11400
45	15284	11333

2'x4' / 3500K

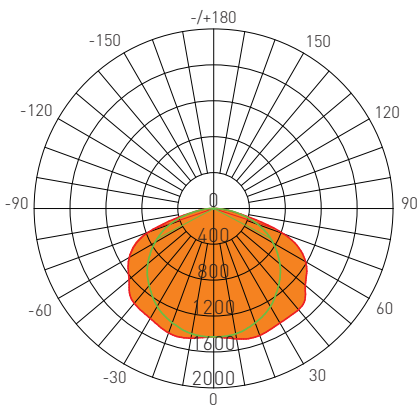

AVERAGE BEAM ANGLE(50%): 133.4°

Test Number: TT24-DM-04W  
 Lumens: 5460.4 Lm  
 Watts: 48.81 W  
 LPW: 111.87 Lm/W  
 CCT: 3500K

UNIT: cd  
 — C0/180,142.8  
 — C90/270,124.1

Zonal Flux Diagram

τ	C0	C45	C90	C135	C180
10	1476	1453	1419	1442	1467
20	1506	1462	1356	1431	1475
30	1475	1412	1264	1363	1415
40	1472	1332	1124	1261	1380
50	1334	1257	965.4	1162	1233
60	1183	1052	764.1	969.1	1087
70	829.5	785.9	526.3	724.8	776.3
80	233.4	277.8	238.8	270.1	223.4
90	1.578	2.350	14.28	2.462	1.629
100	1.451	2.109	2.911	2.214	1.815
110	2.116	2.843	2.507	2.676	2.042
120	2.355	2.863	1.316	2.762	2.115
130	2.238	2.051	1.134	1.924	1.950
140	1.839	1.085	0.9668	0.8426	1.870
150	1.415	0.7827	0.9557	0.7437	1.752
160	1.088	0.7829	1.002	0.7228	1.633
170	1.312	0.8800	1.262	0.9410	1.667
180	1.390	0.9644	1.314	1.081	1.632
DEG	LUMINOUS INTENSITY:cd				

Zonal Lumens

τ	φ total
0-10	137.5
10-20	546.5
20-30	1197
30-40	2032
40-50	2987
50-60	3952
60-70	4807
70-80	5325
80-90	5448
90-100	5451
100-110	5454
110-120	5456
120-130	5458
130-140	5459
140-150	5459
150-160	5460
160-170	5460
170-180	5460
DEG	UNIT: lm

Luminance cd/(m2)

G[DEG]	C0/180	C90/270
85	11179	12390
80	13456	13747
75	18946	14805
70	24285	15384
65	24922	15466
60	23686	15279
55	22066	15111
50	20773	15016
45	20368	14854

# Floating Air Troffer

CCT & Wattage Adjustable Version

## MICROWAVE SENSOR OPTION

Line Voltage Daylight Harvest / Bi-Level



DIP Switch

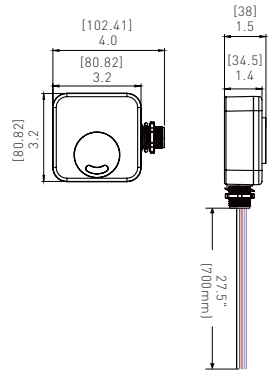

### Specifications

Operating Voltage	120/277VAC, 50Hz/60Hz
Switching Capacity	Resistive/Halogen-800W/1200@120/277V Fluorescent Ballast-660W/1200@120/277V Electronic Ballast(LED/CFL)-5A/5A@120/277V
Stand-by Power	≤0.5W
Detection Area	20%/50%/75%/100%
Hold Time	10s/1min/5min/10min/15min/20min/30min/60min
Daylight Threshold	10Lux/30Lux/50Lux
Stand-by Period	1min/30min/60min/+∞
Stand-by Dimming Level	0%/10%/30%/50%
Microwave Frequency	5.8GHz±5MHz
Microwave Power	< 0.2mW
Mounting Height	Max.6m
Detection Range	Max.8m
Control Line	VIOLET+,GRAY-,RED L'Out, WHITE N, BLACK L in
Operating Temperature	-40°C~+70°C
IP Rating	IP20
Detection Angle	360°

### Detection Pattern

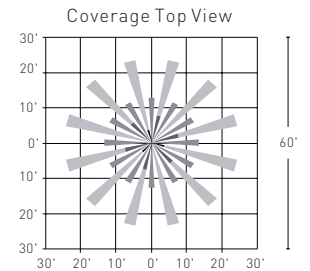
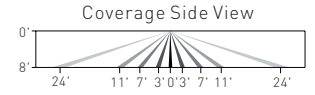

## EMERGENCY OPTION

Up to 120 minutes in event of power failure

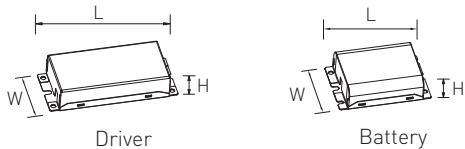
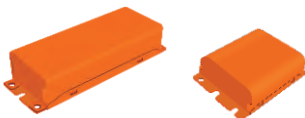

Model		L	W	H
EM-S0854-LBN	Driver	5.08	2.05"	0.99"
	Battery	3.47"	2.33"	0.97"

### Specifications

Output Power	8 Watts
Output Voltage	15-54V DC
Input Current	70 mA (Max)
Input Power	3.2 Watts (Max)
Input Voltage	100-277VAC, 50-60Hz
Emergency Operation	≥90 Minutes
Standby Power	< 0.4W
Operating Temp	0°C to 50°C
Battery	Lithium
Recharge	24 Hrs
Compatible LED Luminaire	LED Driver Output Current: 5A Max
Dimensions	Driver: L5.08"xW2.05"xH0.99", Battery: L3.47"xW2.33"xH0.97"
Certificate	UL , CEC
Output Class	UL LELV (Output protection self-resetting)

