

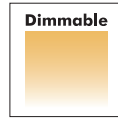

# VSTL-830

120V and 277V  
LED Mini Step Light

**LED**



CA  
Title 24



White

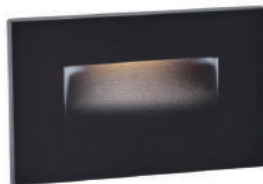

Black

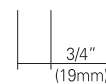
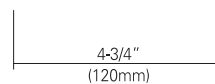
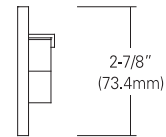
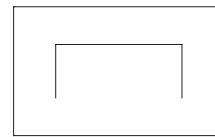

## DESCRIPTION

The VSTL-830 LED Mini Step Light is an easy-to-install low profile fixture that produces an attractive glow. Ideal for lighting low light areas such as corridors or pathways, and can be mounted vertically or horizontally. Available in Outdoor and Indoor as well.

| SPECIFICATION  |                            |
|----------------|----------------------------|
| Input Voltage  | 120V and 277V              |
| Wattage (Typ)  | 5W                         |
| Lumen (Typ)    | 215 lm                     |
| Efficacy (LPW) | 43 lm/W                    |
| CRI (Typical)  | 80, 90                     |
| Color (+/-5%)  | 2700K, 3000K, 4000K, 5000K |
| Dimming        | Triac or 0-10V             |

## DESIGN FEATURES

- Cast aluminum face plate.
- Wet location listed to IP65 for indoor and outdoor installation.
- Diffused lens delivers perfect light distribution.
- 120V AC LED module with integrated IC chip imbed on board and 10-100% Triac dimming with most leading and trailing edge dimmer switches in the market.
- 120V or 277V direct wiring, no driver needed.

### Listing

- CSA-us Certified
- California Title 24
- Wet location

### Limited Warranty

- LED Module: 5 years/50K hours

## Installation

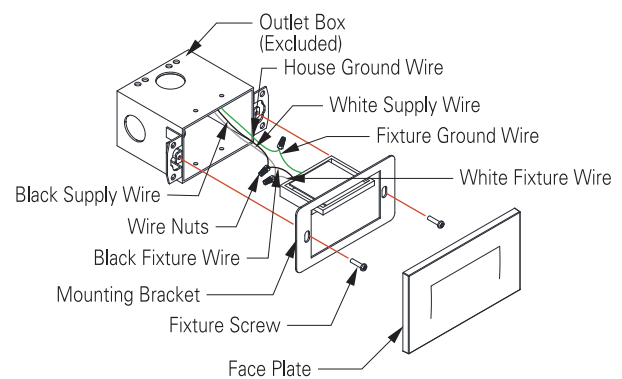

\* Consult factory for approved dimmers

## Ordering Information

| Housing  | -Watts  | -CRI               | Color Temp.**  | -Finish                                    |
|----------|---------|--------------------|--|--|
| VSTL-830 | -5 = 5W | -8 = 80<br>-9 = 90 | 27 = 2700K<br>30 = 3000K<br>40 = 4000K<br>50 = 5000K | -WH = White<br>-BK = Black<br>-BZ = Bronze |

Example : VSTL-830-5-830-WH

\*\* Consult factory for other Color Temperatures and Finishes