

VP260

Gooseneck LED Post Top Light

20W / 35W / 50W / 60W / 80W / 100W



Specifications

Wattage	20W	35W	50W	60W	80W	100W
Installation height (Suggested)	7'-10'	10'-15'	15'-18'	15'-18'	18'-22'	20'-26'
LED Chips	SMD 3030, Philips or other LED chip					
Driver Brand	Meanwell / SOSEN, or other LED driver					
Material	Aluminum alloy+PC lens					
Color Temp	3000K / 4000K / 5000K / 6000K					
Lumen Efficacy	130-135lm / W (Can customize higher LM / W if in need)					
AC Input Voltage	100-277V / 120-347V / 180-480V					
Light Distribution	Type V (120°) / Type III (90*140°)					
Mount Tenon	2 3/8" or 3" Round Tenon (Adapters available)					
Thermal Management	Superior thermal management with external Air-Flow fins					
Ambient Temperature	-40°C to +45°C(-40°F to +113°F)					
Total Harmonic Distortion (THD)	< 15%					
Housing	Bronze or Black Finish					
Lifetime	50,000H					
IP Rating	IP65					
Warranty	5 years					

Features

Compatible With Different Mount Brackets

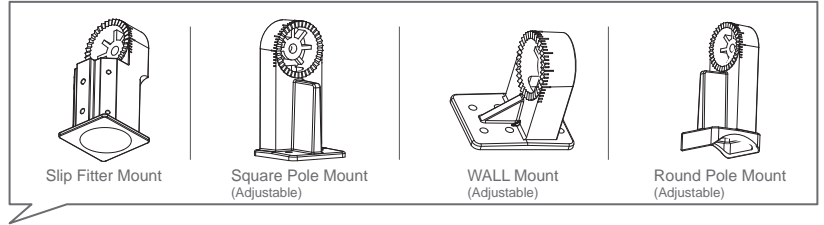

Two Mount for optional

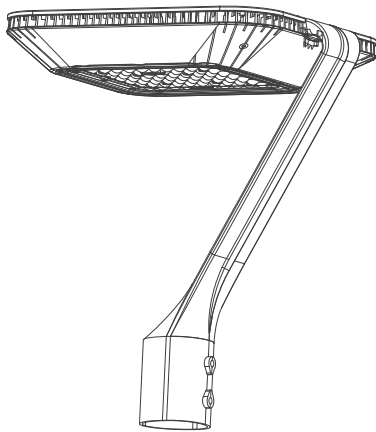

2 3/8" (60mm round pole)

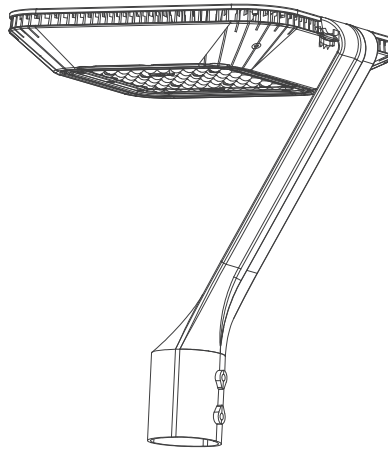

3" (76mm round pole)

Adapters (suitable for 2 3/8" mount)

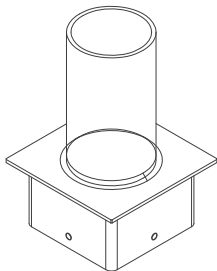

4" SQ

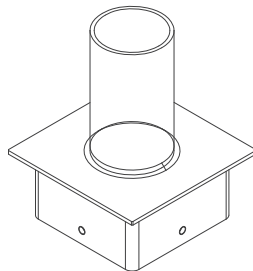

5" SQ

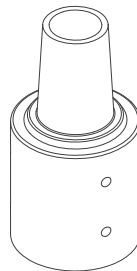

3" RD

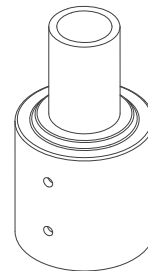

4" RD

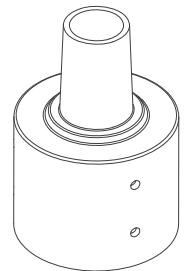

5" RD

Light Distribution

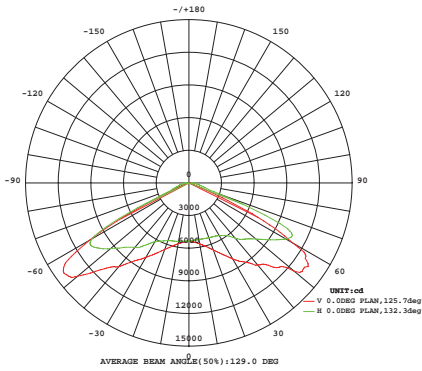

Type V (120°)

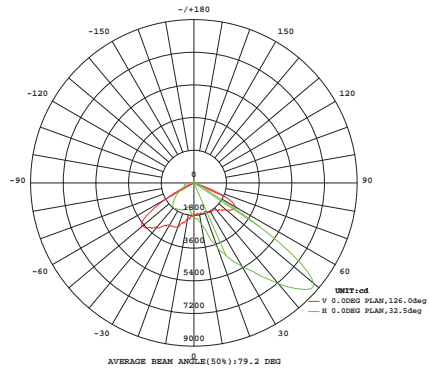

Type III (90°*140°)

Dimension

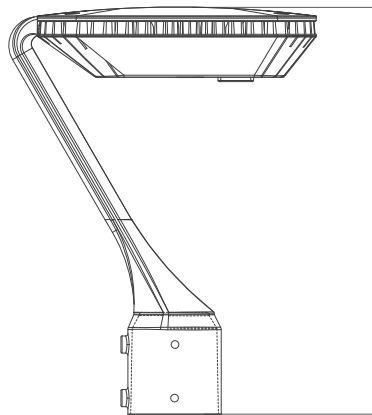
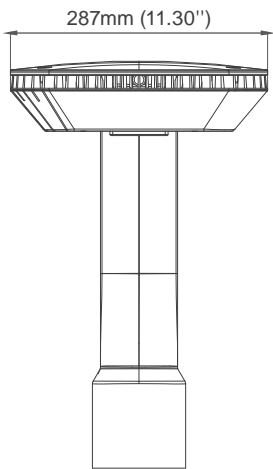

380mm(14.96")

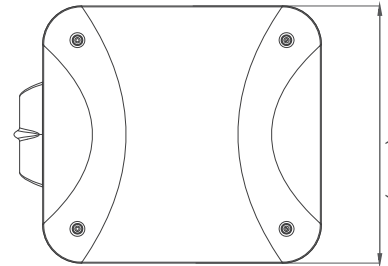

240mm(9.45")

VP260

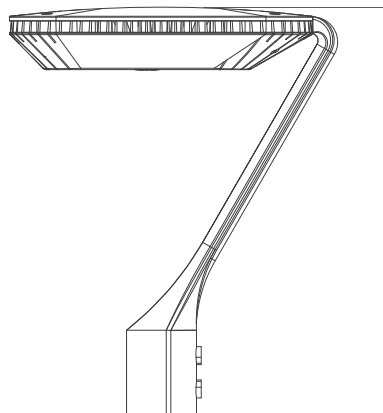
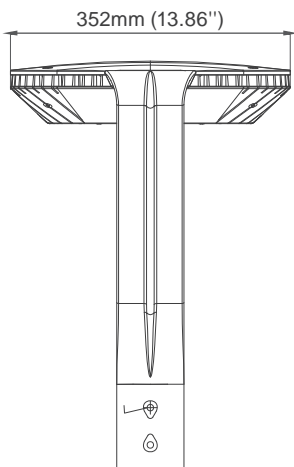

437mm(17.20")

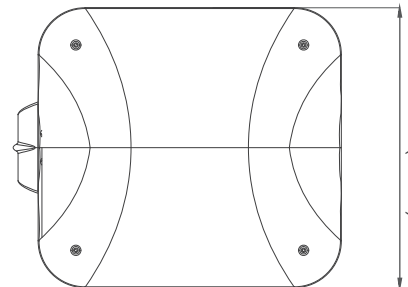

300mm(11.81")

VP325