

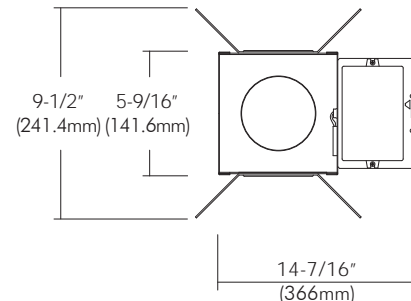

VLEDH-S55

120-277VAC Square 5" X 5" Recessed Fixture, LED COB Chip

5" LED-SQUARE

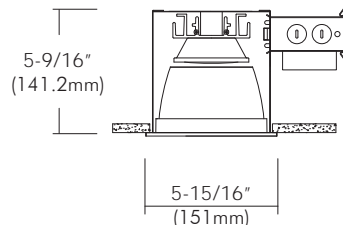
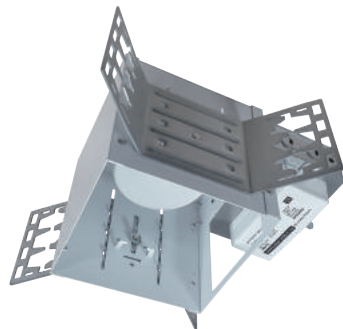

DESCRIPTION

Ceiling Cut-out : 5-5/8" X 5-5/8"

The VLEDH-S55, Square 5"X5" fixture is designed for accent lighting and is provided with a solid state LED engine with integrated aluminum heatsink. The dual reflector system provides excellent cutoff. The electronic, Universal driver is isolated for reliability on the junction box and can be accessed from below the ceiling. Offered in three wattages, 14W, 23W and 30W, the luminaire has a rated LM70 life of 50,000 hours and has high efficacy for long term energy savings. Suitable for Wet Locations.

DESIGN FEATURES

Junction Box

- Listed for through branch circuit wiring. (Max. 8 No 12 AWG 90°C branch circuit conductors.)
- (5) 1/2" knockouts with pry-out slots and (4) knockouts for Romex cable clamp.
- Ground wire provided on J-box.

Mounting Channel Bracket

- Commercial mounting kit provides up to 5" vertical adjustment for accommodates 1/2" EMT conduit, optional HBC-24 bar hanger or lathing channels for T-bar grid or concealed spline ceiling.

Heat Sink

- The aluminum heat sink was computer designed with simulation software to quickly distribute the heat away from the LED module to reduce the LED junction temperature in order to maintain constant light output, color and life of electronic components.

Trims

- See "Trims" spec sheet for selection or ordering information.

Optic

- Precisely designed Inner Reflector attaches to the LED module to provide precise beam control and reduces glare.
- Glass Lens: translucent tempered glass provides high lumen transmission and diffusion for even illumination.

LED Engine

- COB (Chip on board) LED package.
- Aluminum clad PC board is used to dissipate the heat away from the LED module for cooler operation.
- Lumen Maintenance: L70/50, 70% lumens/50,000 hours

LED Power Supply Driver

- Universal, 120~277V input, high efficacy drivers with dimming capability by ① a Triac 120V low voltage electronic dimmer switches or ② 0-10V, Triac & ELV dimmer switches.
- Drivers feature power factor > .90, THD < 20% with integral thermal protection to sense over temperature or electrical issues.
- Driver installed on junction box door for easy access below ceiling.

Limited Warranty

- LED Module: 5 years/50K hours
- Product/Driver: 3 years



Listing

- cETLus Wet Location

SPECIFICATION			
Input Voltage	120-277VAC		
Wattage (+/-5%)	14 W	23W	30W
Lumen (+/-5%)	941	1,516	2,014
Efficacy (LPW)	67.2	65.9	67.1
Beam Angle	54°	54°	54°
CRI (Typical)	80, 90		
CCT (Color +/-5%)	2700K, 3000K, 3500K, 4000K		
Dimming	Triac (Standard), 0-10V		
LED Module	5 yr/50K hr		
Environment	Damp & Wet Location		

◦ Triac Approved Dimmers	
* Lutron: NovaT (Ntelv 300 & 600)	Diva (Dvelv-300P & 303P)
* Leviton: Acenti: Ate06-1Lw	
* Leviton Trimatron #705W (Incandescent)	
<i>Consult tech. service or factory for additional dimmers</i>	

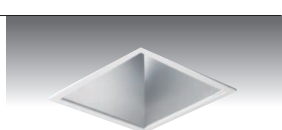
TRIMS

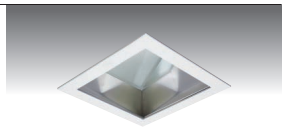
<p>QT-522</p>	<p>Haze Clear Square Reflector with Regressed Frosted Lens Die-cast Aluminum Flange Frame : 6-1/4" SQ."</p>	 <p>QT-522-HC-WH</p>
<p>QT-529</p>	<p>Haze Clear Square Reflector Die-cast Aluminum Flange Frame : 6-1/4" SQ."</p>	 <p>QT-529-HC-WH</p>
<p>QT-535R</p>	<p>Haze Clear Reflector with Flat Frosted Lens Die-cast Aluminum Flange Frame : 6-1/4" SQ."</p>	 <p>QT-535R-HC-WH</p>
<p>QT-538</p>	<p>Haze Clear Square Wall Wash Reflector with Linear Spread Lens Die-cast Aluminum Flange Frame : 6-1/4" SQ."</p>	 <p>QT-538-HC-WH</p>

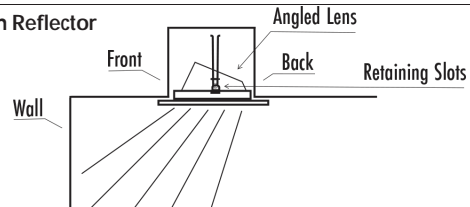

PHOTOMETRIC REPORT *

* Contact Factory for IES File

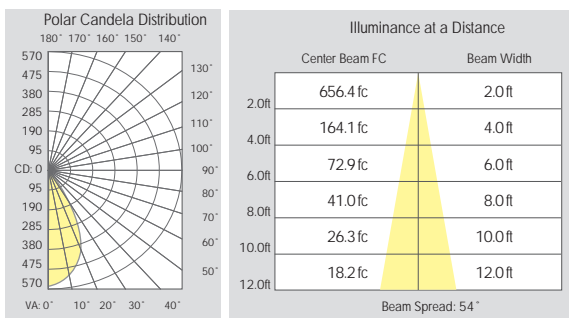

Option

TML-519-MUD
[5" Square Flangeless Mud Frame]

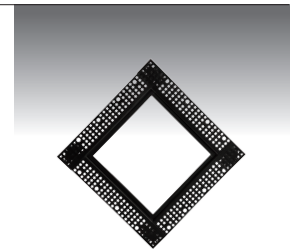
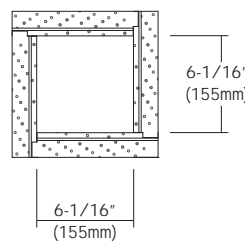

[LEDH-S55-30]

Trimless Ceiling Cut-out : 6-3/8" (162mm)SQ

Ordering Information

Model	-Watts	-CRI	Color Temp. *	Driver	Trim	-Finishes*	-Diecast Flange / Flangeless
VLEDH-S55 = Square 5" X 5" Recessed Fixture	-14 = 14W -23 = 23W -30 = 30W	- 8 = 80 CRI - 9 = 90 CRI	27 = 2700K 30 = 3000K 35 = 3500K 40 = 4000K	UTD = 120-277VAC, Triac: 10-100% Dimming UZTD = 120-277V, 0-10V, Triac & ELV: 1-100% Dimming * - Option -EM = Emergency battery backup	QT-522 QT-529 QT-535R QT-538	Reflector: -HC = Haze Clear -WH = White Painted	-WH = White -BK = Black -TML-519-MUD = Flangeless Mud Frame

Example : VLEDH-S55-14-830UTD

QT-535R-HC-WH

* Consult factory for other Color Temperatures and Finishes