

Cylinder

VCY Series | Surface Mounted | Round Downlights



ValueEngineeredLighting
ARCHITECTURAL LIGHTING PRODUCTS

V.E. Lighting offers numerous cylinder lighting options that complement our suspended lighting platform, while providing a consistent aesthetic. Performance and beauty are both in play with our sleek architectural cylinders.

Our cylinder would greatly create possibilities in the whole commercial area which make light modular with multiple sizes, beam options, and high visual comfort COB LED as its standard configuration. It is now available in pendant and surface mount configurations which offers a beautiful and slender solution.



Feature

- Modular design
- COB LED chip: 80+ standard, 90+ optional
- Dimming: 0-10V(10% standard, 1% optional) or TRIAC
- Beam angle: 15°, 24°, 36°, 60° options
- Architectural form : 4", 6" and 8"
- Mounting: Surface or pendant
- Wattage Selectable



PERFORMANCE

Dimension	Wattage Selectable	Efficacy	Lumens
4"	15w/20w/25w	90lm/w	1300-2200lm
6"	20w/30w/40w	105lm/w	2100-4200lm
8"	36w/48w/60w	90lm/w	3200-5400lm

* Above apply to 3000K, 80+ CRI values only. Check the IES file to gain the other accurate data.

Standard Aluminum Trims



Decorative Trims

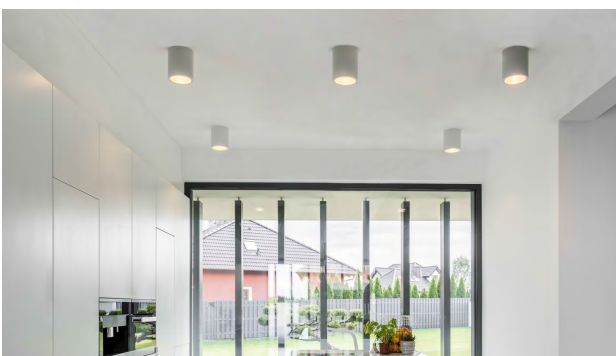

Cylinder

VCY Series | Surface Mounted | Round Downlights

STRUCTURE

► Optics

It was powered by high efficiency COB LED chip. 15° / 24° / 36° / 60° fixed beam spread options. Cylinder beamspreads are interchangeable which can be easily swapped out in the field without tools.

► Finish

Constructed of rigid die cast aluminum. Powder coated polyester paint that comes standard in white and black.

► Electrical

LED Driver	It is powered by Class 2 high efficiency LED driver, with a standard 0-10V dimming which continuous dims to 10% that works with many types of controls. Tested Dimmers: Lutron® Diva-Dvtv, Leviton® IP-710-DL. Dim down to 1% is optional upon request by consulting the factory. TRIAC dimming is available.
THD	<20%
Power Factor	>0.9
Input Voltage	Standard electronic drivers are cULus recognized and available for 110-277V AC or 110~347V AC.

► LED System

CRI	COB LED with a 80+ is standard. 90 CRI is also available upon request by consulting the factory. They have been tested in accordance with IESNA LM-80 and the results have shown L80 lumen maintenance greater than 50,000 hours.
CCT	2700K,3000K, 3500K and 4000K with a great color consistency.
Thermal Management	Aluminum housing acting as the heat sink to maximize life.

► Listings

- cULus listed for damp locations
- 5 years limited warranty

Notes:

- Ambient temperatures at fixture location should not exceed 40°C during normal operation.
- For interior use only

► Optional Function

Emergency Option	Optional high voltage 8W emergency LED driver EM-H08170-LBF can be provided. When AC power fails, it immediately switches to the emergency mode, operating for lighting up to 120 minutes. When AC power is restored, it automatically returns to the charging mode which meets critical life-safety lighting requirements. For more info or spec sheet, please visit our website or contact sales.
------------------	---

Emergency Lumen Output:

Fixture Efficacy	Output Power 8w
90lm/w	720 Lumens

► Mounting Options

For Recessed J-box

If recessed J-box is existing (3" octagon, 4" octagon and 4" round), the cylinder can be mounted directly to recessed mounted junction box.

For Surface Mount J-box

If standard 4" octagonal J-box is surface mounted, a Ø5.97" round x 2.38" deep canopy with conduit cutout is provided for mounting. Conduit cutout canopy has 4 key slots, one in each side, and can be configured to accommodate any ceiling layout using ½" or ¾" conduit. Conduit cutout canopy is provided white and black powder coat painted finish.

Conduit cutout mounting example

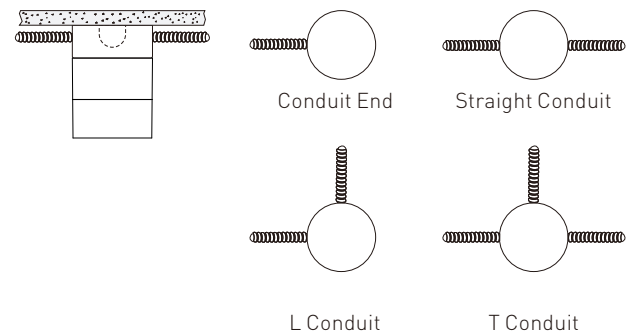







Cylinder

VCY Series | Surface Mounted | Round Downlights

PRODUCT ORDERING GUIDE

Example: CY6R-SS35W-8010WHAW

VCY		R	-			-			
Product Family	Product Size	Product Shape	Mounting Options	LED Color Options	Beam Options	CRI Options	Dimming Options	Finish	Trim Options
VCY Cylinder series	4 4inch, Wattage Selectable 25W/20W/15W	R Round S Square	SS Surface Mount To Recessed Junction Box PS Surface Mount With Conduit Cutout For Surface Mounted 4" Octagonal Junction Box	27 2700K COB	N Narrow Beam, 15° M Medium Beam, 24° W Wide Beam, 36° F Flood Beam, 60°	80 80+ CRI (Standard) 90 90+ CRI (Optional)	0-10V	WH White BK Black	Standard Aluminum
	30 3000K COB			10 Dims to 10% (Standard)					
	6 6inch, Wattage Selectable 40W/30W/20W			35 3500K COB			01 Dim to 1% (Optional)	AB  Black Baffle	
8 8inch, Wattage Selectable 60W/48W/36W	40 4000K COB	TR TRIAC Dimming (Optional)	AG  Gold Baffle						
							Decorative Options		
							DY  Yellow		
							DG  Green		
							DW  White		
							DB  Blue		
							DR  Red		

Mounting Option

Surface Mounted To Recessed J-Box



4" / 6" / 8"

Surface Mounted Conduit Cutout To Surface J-Box

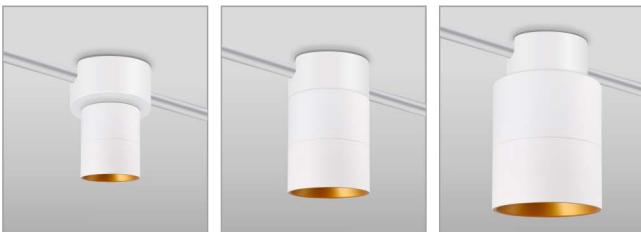

4"

6"

8"

Product Portfolio Configuration

Standard Aluminum Trims



Decorative Trims



Cylinder

VCY Series | Surface Mounted | Round Downlights

DIMENSIONS

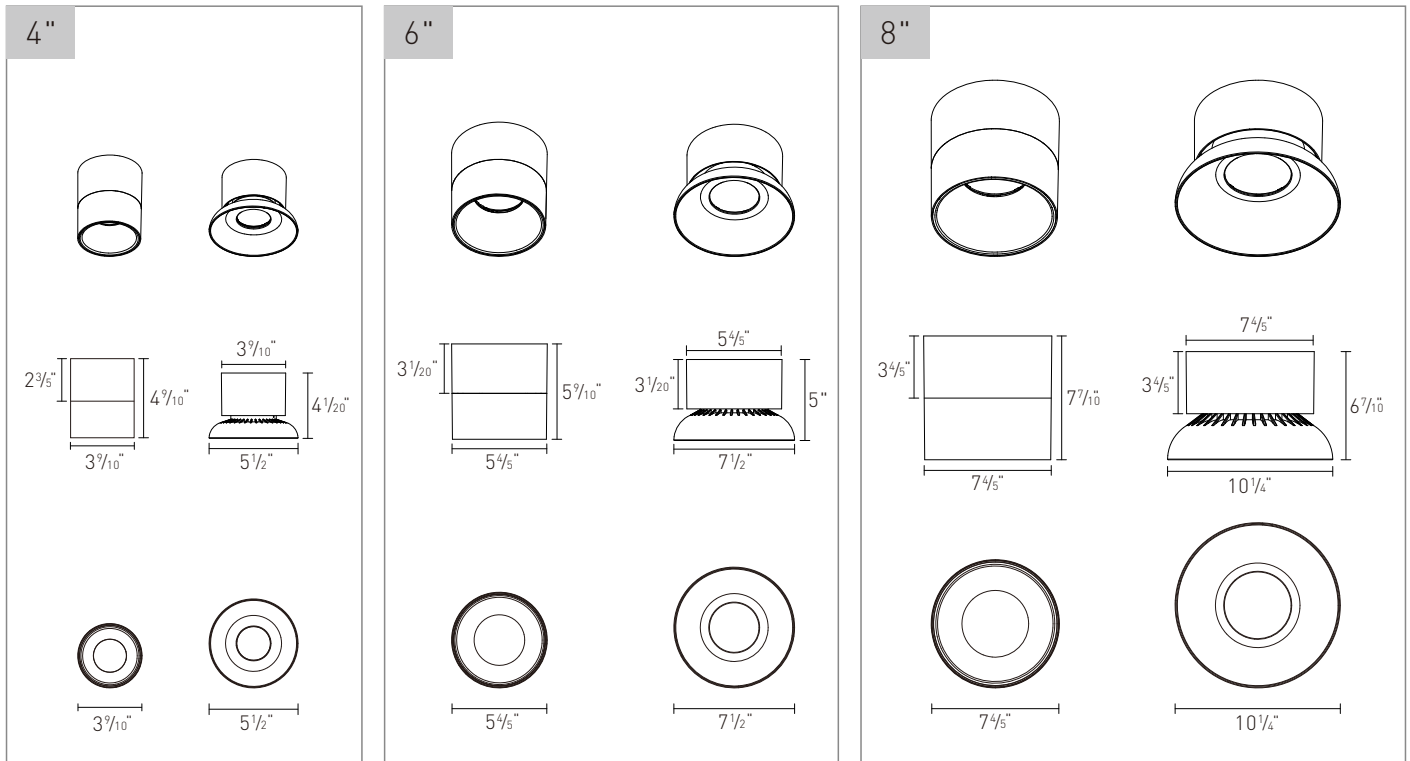

DISTRIBUTION DIAGRAM

4" / 3000K / 60°

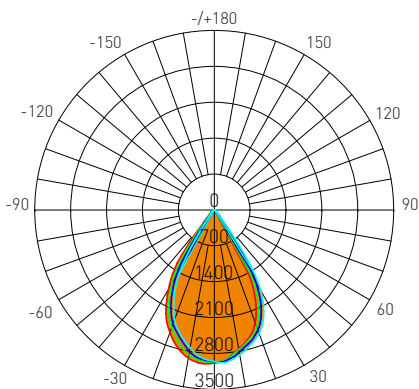

AVERAGE BEAM ANGLE(50%): 61.0°

Test Number: CY4R-SS30F
 Lumens: 2612.6 Lm
 Watts: 25 W
 LPW: 103.94 Lm/W
 CCT: 3000K

UNIT: cd
 C0/180, 61.0°
 C30/210, 61.1°
 C60/240, 61.1°
 C90/270, 60.7°

Zonal Flux Diagram

τ	C0	C45	C90	C135	C180
10	2751	2786	2868	2917	2931
20	2335	2466	2558	2593	2538
30	1094	1535	1818	1905	1800
40	155.1	194.4	245.3	438.2	400.3
50	62.68	63.03	65.58	79.00	102.6
60	44.26	44.48	45.54	54.19	62.64
70	23.80	23.01	22.92	28.39	34.03
80	2.913	5.007	6.675	7.312	11.58
90	0.1544	0.1118	0.3414	0.4778	0.2661
100	0.0980	0.1167	0.1027	0.1260	0.1499
110	0.1725	0.2939	0.8678	0.2707	0.6863
120	0.3081	0.3082	0.3596	0.3502	0.7190
130	0.8022	0.6450	0.4290	0.4484	0.8034
140	2.066	1.785	1.408	1.243	1.589
150	3.714	3.274	2.851	2.718	3.120
160	5.316	4.917	4.461	4.184	4.698
170	6.381	6.205	6.044	5.930	6.233
180	6.788	6.806	6.652	6.657	6.797

DEG LUMINOUS INTENSITY:cd

Zonal Lumens

τ	φ total
0-10	275.7
10-20	1016
20-30	1941
30-40	2403
40-50	2499
50-60	2552
60-70	2587
70-80	2603
80-90	2605
90-100	2605
100-110	2605
110-120	2606
120-130	2606
130-140	2607
140-150	2609
150-160	2610
160-170	2612
170-180	2613

UNIT: lm

Luminance cd/(m2)

G(DEG)	C0/180	C90/270
85	2079	6732
80	2892	6628
75	8458	9206
70	11997	11556
65	13945	13764
60	15263	15703
55	16203	17152
50	16813	17592
45	17695	27503

Cylinder

VCY Series | Surface Mounted | Round Downlights

DISTRIBUTION DIAGRAM

6" / 3000K / 60°

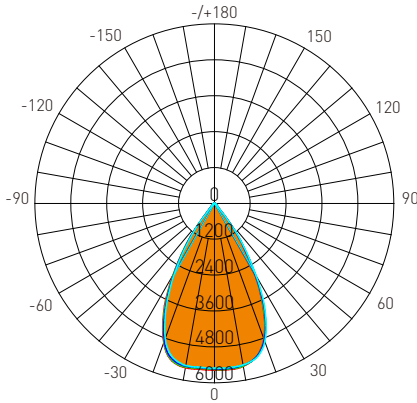

AVERAGE BEAM ANGLE(50%): 59.6°

Test Number: CY6R-SS30F
 Lumens: 5046.4 Lm
 Watts: 45 W
 LPW: 111.38 Lm/W
 CCT: 3000K

UNIT: cd
 C0/180, 59.5°
 C30/210, 59.5°
 C60/240, 59.6°
 C90/270, 59.6°

Zonal Flux Diagram

τ	C0	C45	C90	C135	C180
10	5529	5511	5486	5486	5576
20	4834	4887	4923	4940	4963
30	2643	2758	2803	2894	2818
40	433.5	487.4	508.0	551.8	472.2
50	100.6	104.4	102.4	105.5	99.85
60	72.33	72.16	70.84	70.56	71.23
70	44.46	45.15	44.15	44.05	43.76
80	18.19	18.90	17.92	18.39	18.56
90	0.1782	0.1447	0.1496	0.1447	0.1447
100	0.1727	0.1868	0.1494	0.1821	0.1729
110	0.2565	0.2615	0.2147	0.2568	0.2569
120	0.3688	0.3923	0.3823	0.3596	0.3737
130	1.082	1.047	0.9929	0.9770	1.080
140	3.232	3.112	3.031	2.920	3.318
150	6.392	6.202	6.089	5.889	6.530
160	9.529	9.302	9.245	9.017	9.601
170	12.21	12.07	11.91	11.77	12.11
180	13.29	13.37	13.15	13.16	13.31
DEG	LUMINOUS INTENSITY:cd				

Zonal Lumens

τ	φ total
0-10	526.3
10-20	2017
20-30	3780
30-40	4714
40-50	4863
50-60	4936
60-70	4993
70-80	5025
80-90	5033
90-100	5033
100-110	5033
110-120	5033
120-130	5034
130-140	5036
140-150	5039
150-160	5042
160-170	5045
170-180	5046
UNIT: lm	

Luminance cd/(m2)

G(DEG)	C0/180	C90/270
85	5141	5059
80	6800	6703
75	7678	7640
70	8441	8382
65	9032	8906
60	9393	9200
55	9336	9072
50	10163	10349
45	14737	15549

8" / 3000K / 60°

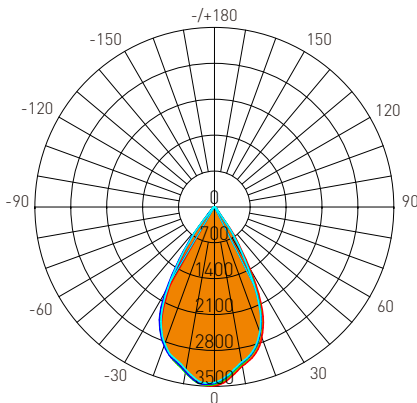

AVERAGE BEAM ANGLE(50%): 57.7°

Test Number: CY8R-SS30F
 Lumens: 6000.6 Lm
 Watts: 60 W
 LPW: 95.85 Lm/W
 CCT: 3000K

UNIT: cd
 C0/180, 57.5°
 C30/210, 57.8°
 C60/240, 58.0°
 C90/270, 57.5°

Zonal Flux Diagram

τ	C0	C45	C90	C135	C180
10	6752	6641	6582	6635	6997
20	5798	5610	5550	5774	6119
30	2943	2631	2544	3088	3598
40	323.2	281.4	268.1	369.4	569.4
50	101.4	92.02	90.41	103.3	137.4
60	66.11	63.45	62.41	64.37	68.46
70	40.56	38.05	37.37	39.94	43.13
80	16.48	14.58	14.33	16.84	19.29
90	0.1635	0.1495	0.1728	0.1494	0.6340
100	0.1633	0.2008	0.1867	0.1961	0.1821
110	0.2426	0.2895	0.2613	0.2755	0.2615
120	0.4150	0.4624	0.4521	0.4110	0.3877
130	1.310	1.501	1.445	1.183	1.038
140	4.020	4.396	4.323	3.738	3.636
150	7.830	3.274	2.851	2.718	3.120
160	11.69	12.09	12.00	11.29	11.30
170	15.06	15.17	14.99	14.64	14.78
180	16.06	16.06	15.84	15.86	16.12
DEG	LUMINOUS INTENSITY:cd				

Zonal Lumens

τ	φ total
0-10	670.6
10-20	2462
20-30	4629
30-40	5655
40-50	5820
50-60	5892
60-70	5945
70-80	5976
80-90	5984
90-100	5985
100-110	5985
110-120	5985
120-130	5986
130-140	5988
140-150	5991
150-160	5995
160-170	5999
170-180	6001
UNIT: lm	

Luminance cd/(m2)

G(DEG)	C0/180	C90/270
85	2815	2099
80	3569	3101
75	4060	3666
70	4458	4108
65	4761	4451
60	4970	4692
55	5058	4836
50	5932	5288
45	9205	8235