

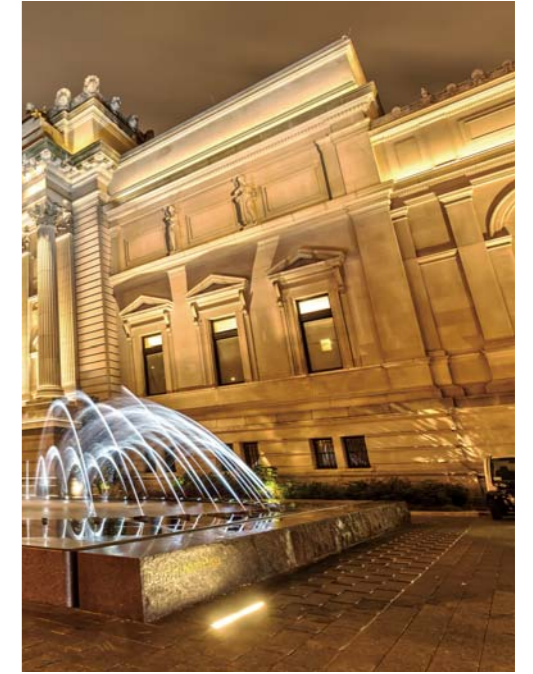







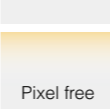

- Quick connection
- Dimmable, 1-10V dimming to 10%-100%
- Linkable, max. linkable length: 72' @120VAC, 156' @277VAC
- Lockable, precision aiming adjustment: $\pm 85^\circ$ vertical rotation
- IP rating: IP66 (for wet locations)
- Lifetime: 50,000hrs (ta=95°F, 35°C)
- Ta: -13°F~122°F (-25°C~50°C)
- 10W/ft, 1050lm/ft
- Material: Aluminum alloy
- Other color temp available

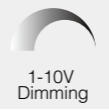

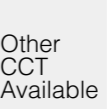
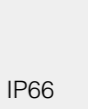
APPLICATION



 Pixel free	 Linkable	 Surface mount	 1-10V Dimming	 3000K 3500K 4000K	 50,000hrs	 Other CCT Available	 IP66
 UL LISTED	 DLC	 Title 24 JAB Compliant					

Dimensions: inches, (mm)



Photometrics

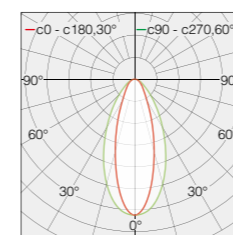

- 0/1-10V dimmable
- $\pm 85^\circ$ vertical rotation
- Waterproof IP66

How to order using our catalog numbers

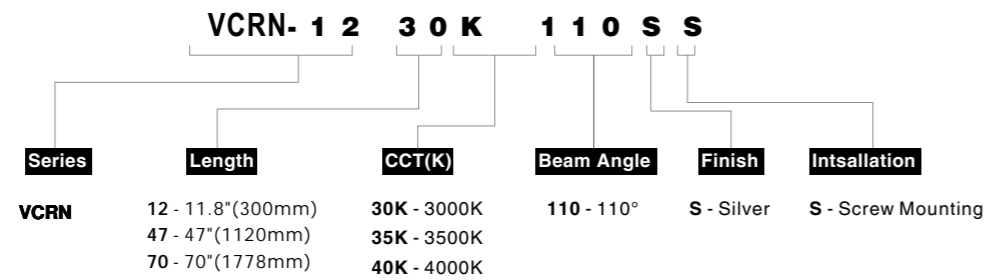

Specifications

Catalog No.	Model	Rated Input (VAC)	Ra	Power (W)	Luminous flux (lm)
VCRN-1230K110SS VCRN-1235K110SS VCRN-1240K110SS	VCRN-L24-277V	120-277	90	10	980 1023 1050
VCRN-4730K-110SS VCRN-4735K110SS VCRN-4740K110SS	VCRN-L90-277V	120-277	90	40	3919 4091 4200
VCRN-7030K110SS VCRN-7035K110SS VCRN-7040K110SS	VCRN-L144-277V	120-277	90	60	5878 6136 6300

* Included: 1 pc LED fixture, 2pcs screws.

Accessories

Catalog No.	Description	Image
IC-VCRN-59 Input cable	Input cable Length 59"	
IC-VCRN-84 Input cable	Input cable Length 84"	
IC-VCRN-180 Input cable	Input cable Length 180"	
SC-VCRN-12 Soft connector optional	Soft connector Length 12"	
SC-VCRN-48 Soft connector optional	Soft connector Length 48"	
SC-VCRN-98 Soft connector optional	Soft Connector Length 98"	

Wiring

AC connection :

Black: " L "

White: " N "

Yellow/green: " ⊕ "

Dimming connection :

Violet: " + "

Gray: " - "

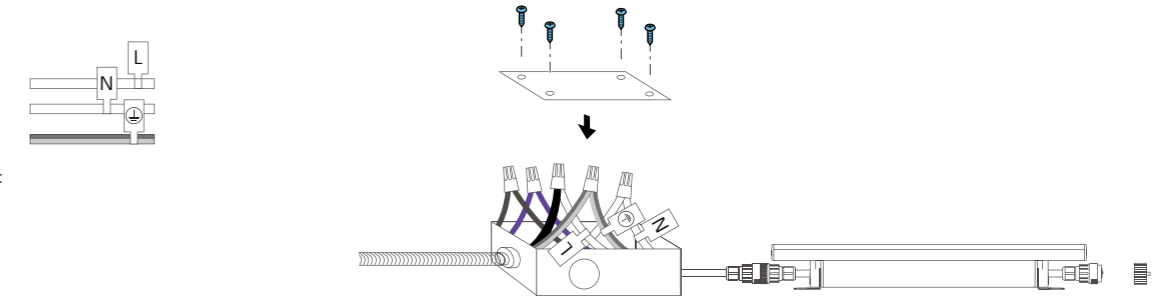

Installation

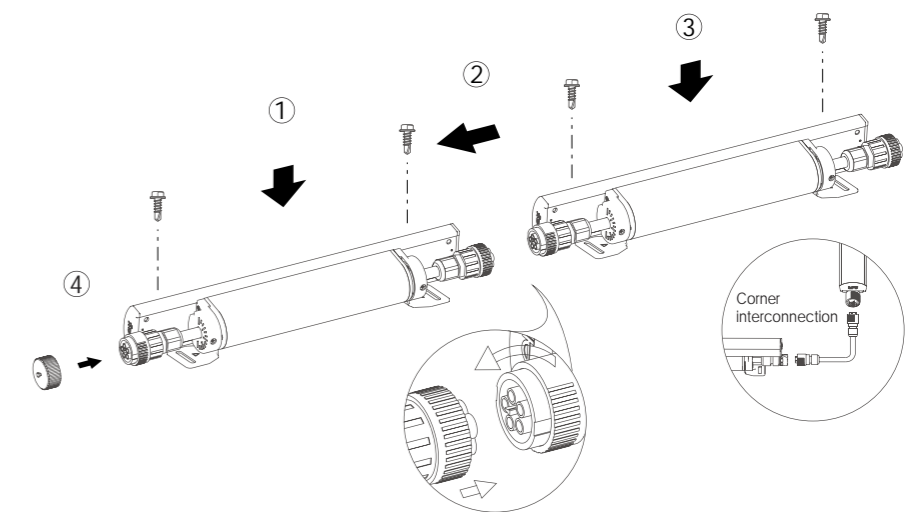

Application

