

Series VBR-B1 Adjustable LED Spot Downlight | IC | Canless

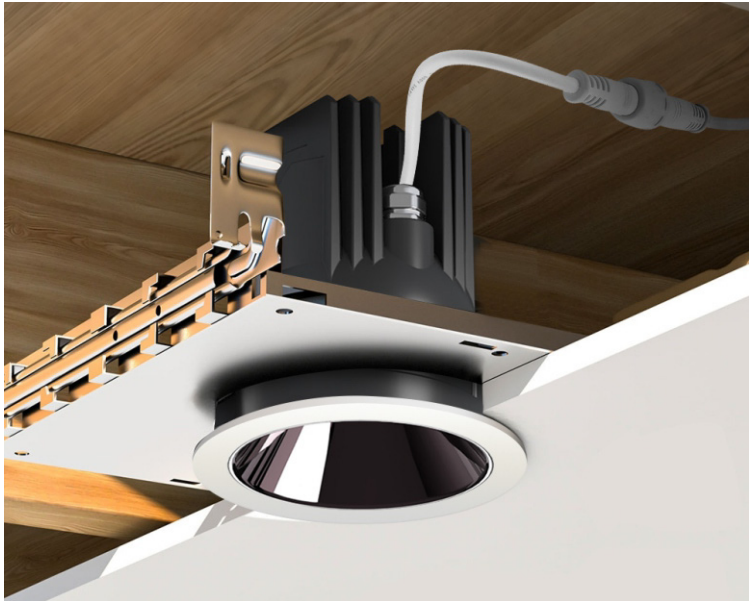

DESCRIPTION

Charlie Series recessed LED downlights provide an architectural lighting solution that enhances luxury spaces with minimal ceiling intrusion. Available in both Round and Square apertures, the family offers multiple configurations, including flangeless (trimless) options, a wide range of reflectors, media, and beam angles (15°–55° available), delivering precise, high-performance illumination for commercial hospitality, high-end residential, and apartment applications.

The fixture supports universal input voltage (120-277V, 50/60Hz), ensuring compatibility across diverse electrical systems. It is dimmable to 1% via 0-10V, electronic low-voltage (ELV), or Triac drivers. The sealed IP65-rated design protects internal components from water, dust, and debris, making it suitable for indoor or damp locations in remodel and new construction projects.

Optics Beam Spread

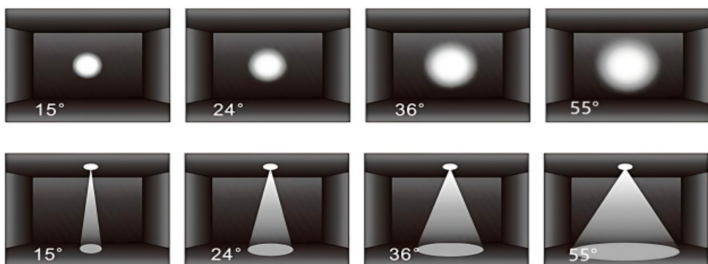

Reflector Available

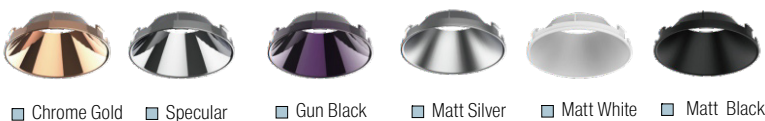

Extra Accessories if required.

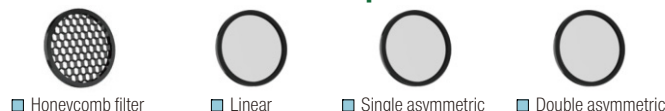

OPTICS TECHNOLOGY

OPTICS	15°, 24°, 36°, 55° Available
ADJUSTABLE	Adjustable Available
MEDIA	Standard Clear, Frosted or Customized Linear Spread, Hex Louver

LED LIGHT ENGINE

RATED WATTAGE	Up to 36W
DELIVERED LUMENS	Up to 3600 lm (based on 100lm/w@4000K with high efficacy COB)
CCT/CRI	2700K, 3000K, 3500K, 4000K, 5000K, 5700K 90CRI, 5 CCT Selectable
COLOR QUALITY	CRI90+, SDCM3
LED LIFETIME	55,000 hours @ L90
CCT/CRI	WARM DIM 3000K-1800K, TUNABLE WHITE 3000K-6500K 90CRI

HOUSING INSTALLATION

- New Construction: Galvanized steel adjustable hanger bars (standard)
- New Construction: Galvanized steel rough-in plate (non-adjustable hanger bars available)
- Remodel installation option available
- IC-rated shallow housing for direct contact with insulation
- Ceiling Compatibility: Drywall or T-bar grid (if required)
- Steel junction box with up to 4 x "knockouts for 1/2" conduit electrical pipes

KEY FEATURES

Adjustable LED Downlight -IP44

- High End Design with deep regress with remote driver j-box
- Electrical supply 120V, 100-277V, 100-347V available
- Optional Triac/Elv/0-10V/Dali Dimmable functions or Triac/ELV/0-10V 3 IN 1 driver optional
- Available in single CCT, 5CCT, and Warm Dim 2700K/3000K-1800K Easy and quick installation to the ceiling
- Type IC rated & No recessed housing or J box required
- Suitable for indoor Dry, Damp locations
- Flexibility to switch color temperature during installation to suit a specific application
- CCT Selectable via a dip switch located on junction box
- 5 year warranty on fixture and electronics
- ETL Listed to US and Canadian standards (cETL,ETLus)

Trim Options

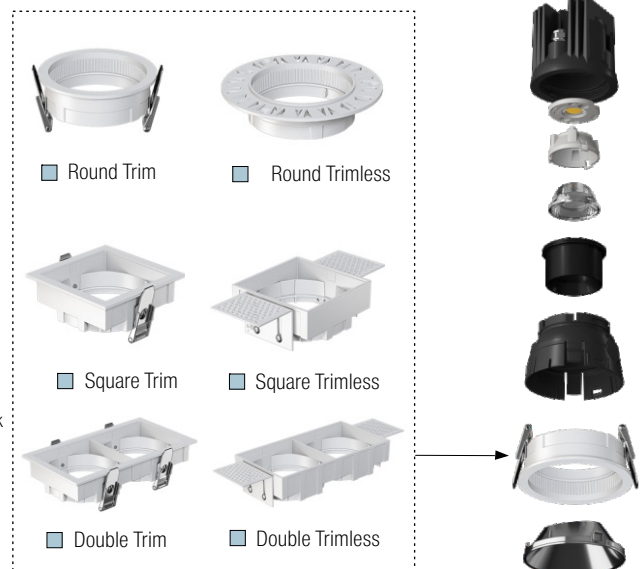

Charlie Series | Canless | Adjustable Downlight | IP44/IP65



SERIES MEASUREMENT: 2"(8W) /3"(12W) /4"(15W)

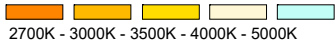
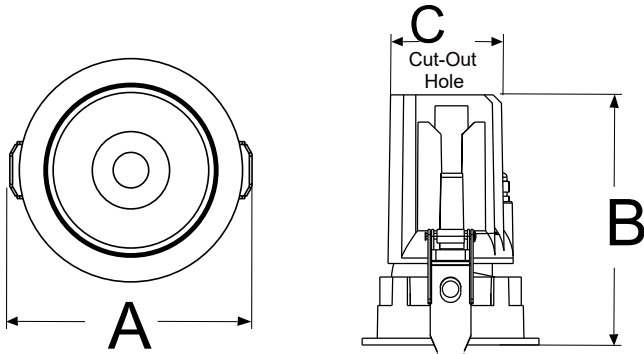

2700K - 3000K - 3500K - 4000K - 5000K

INDICATE	A	B	C (Cut-Out Hole)
VBR2-B1	Ø:2.56" (65mm)	H: 3.7" (94mm)	Ø:2.17" (55mm)
VBR3-B1	Ø:3.23" (82mm)	H: 3.86" (98mm)	Ø:2.95" (75mm)
VBR4-B1	Ø:4.13" (105mm)	H: 4.45" (113mm)	Ø:3.74" (95mm)

ORDERING GUIDE

2"/3"/4" Recessed LED Spot Downlight

CATALOG #

ORDER MATRIX
REMODEL OR NEW CONSTRUCTION

Order Code	Size	Wattage	CCT & CRI	Distributions	Voltage & Dimming Level	Emergency	Reflector Color	Mounting Options	Accessories
VBR2-B1	2= series 2" rough opening	2" 7W / 8W	27 = 2700K,90 CRI, 30 = 3000K,90 CRI, 35 = 3500 K,90 CRI	N = Narrow,15° S = Spot,24° M = Medium,36° W = Wide,55°	Blank = Standard 120Vac, Phase Dimming (Forward/Reverse), Dim to 1%/5%(120V only) 277 = Universal 100-277Vac, 0-10V Dimming to 1%/5% 347 = Universal 100-347Vac, 0-10V Dimming to 1%/5% DALI = Universal 100-277Vac, Dali Dimming to 1%/5% PoE = 12/24Vdc, Constant Voltage Dimming to 100%/5%	ST = Standard No Emergency Pack EL = EMBB	MW = Matte White MB = Matte Black MS = Matt Silver SP = Specular CG = Chrome Gold GB = Gun Black	MO1 = Flanged Plate With Hanger Bars Model MO2 = 26" Flat Rough-In Plates MO3= 13" Mounting Plate Flat MO4= Universal Mounting New Construction Plate MO5= New Construction Housing, IC airtight	EC= Extension Cable P= Plastic C1= Clamp Connector C2= Clamp Connector
VBR3-B1	3= series 3" rough opening	3" 7W / 9W / 12W 4" 7W / 9W / 12W / 15W	40 = 4000 K,90 CRI 50 = 5000 K,90 CRI 5CCT = 2700K-3000K -3500K-4000 K-5000K WD = Warm Dim 3000K-1800K TW = CCT Tunable White, 2700K-6500K						
VBR4-B1	4= series 4" rough opening								

Note: please select the new construction plate size from the accessories kits from page 1 when ordering. (Note: This is for reference only)

<p>MO1 Flanged Plate With Hanger Bars Model</p>	<p>MO2 26" Flat Rough-In Plates</p>	<p>MO3 13" Mounting Plate Flat</p>	<p>MO4 Universal Mounting New Construction Plate</p>	<p>MO5 New Construction Housing, IC airtight</p>	<p>ST EM Backup LED Driver</p>	<p>EC Extension Cabl P C1 C2 Plastic/Clamp Connector</p>
---	---	--	--	--	------------------------------------	---

