



VFL-07-G24 LED Sports Light



Better solutions for LED Sports Light

 IP66 Water-proof

 AC120-277V 50/60Hz

 Easy Installation

 150Lm/W 170Lm/W

Operating Temp.: -40°C~+50°C

Storage Temp.: -40°C~+80°C



Options

Power	Color	Beam Angle	Control Optional
INVENTRONICS Driver	3000K	5°	ON/OFF
Lifud Driver	4000K	10°	0-10V
	5000K	15°	DALI
	5700K	30°	DMX 512
		60°	ZigBee

Application

Sports Lighting, Stadium lighting, Sports fields, Car parks, High mast installations Dock, railway and container yards, Ports and other large scale outdoor applications, Architectural lighting, Landscape lighting, Industrial and commercial exterior lighting Decorative lighting for holidays, tradeshow, exhibitions.

Specifications

Item	Power	Effi.	Leds	CRI	Weight	Beam Angle
FL300W-07-G24	300W	130Lm/W	OSRAM Leds	>70	16.10kg(35.49lbs)	5°
		150Lm/W	OSRAM Leds		15.00kg(33.07lbs)	10°/15°
		170Lm/W	SMD 5050		15.00kg(33.07lbs)	30°/60°
FL400W-07-G24	400W	150Lm/W	OSRAM Leds	>70	15.00kg(33.07lbs)	10°/15°
		170Lm/W	SMD 5050			30°/60°
FL500W-07-G24	500W	150Lm/W	OSRAM Leds	>70	15.00kg(33.07lbs)	10°/15°
		170Lm/W	SMD 5050			30°/60°
FL600W-07-G24	600W	150Lm/W	OSRAM Leds	>70	15.20kg(33.51lbs)	10°/15°
		170Lm/W	SMD 5050			30°/60°
FL800W-07-G24	800W	150Lm/W	OSRAM Leds	>70	15.70kg(34.61lbs)	10°/15°
		170Lm/W	SMD 5050			30°/60°



Dimensions(mm)

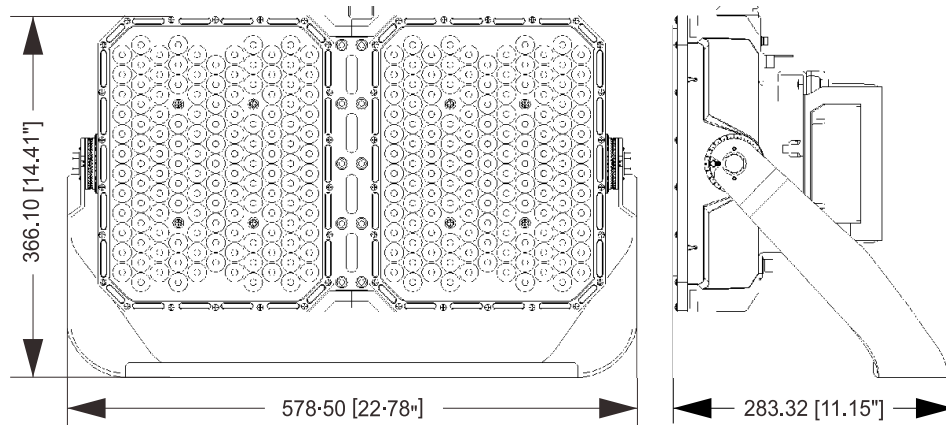

300W/400W/500W/600W/800W-P1A

Photometry

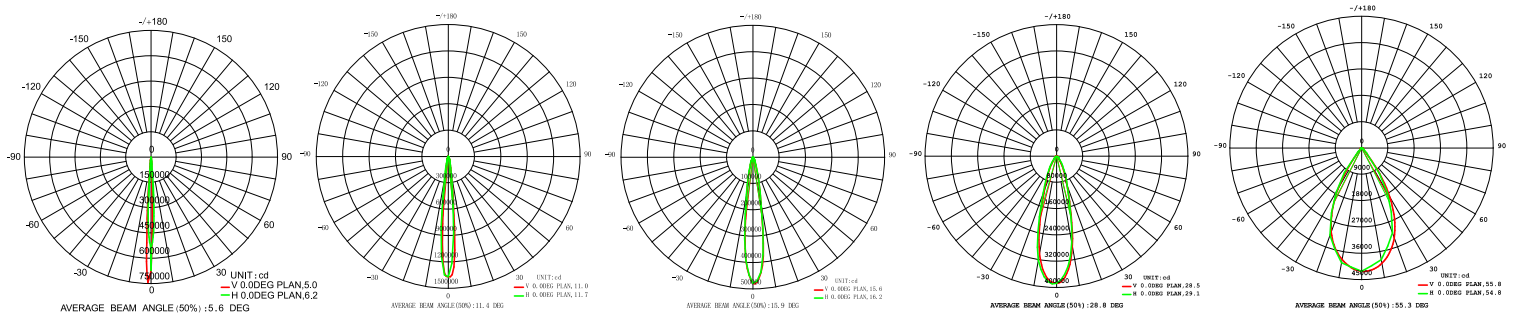

5°

10°

15°

30°

60°



Model Options



P1A-Bracket+ Driver box mounted on the lamp body



P1B-Bracket + Separate remote installation



P2A-Base + Driver box mounted on the lamp body

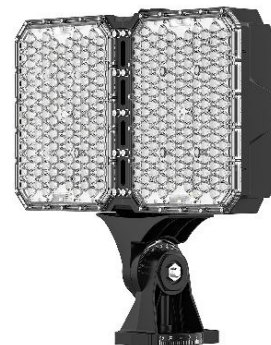

P2B -Base + Separate remote installation



P3A -Slip fitter + Driver box mounted on the lamp body



P3B -Slip fitter + Separate remote installation

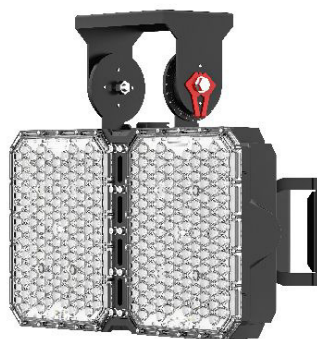

P4A -Trunnion + Driver box mounted on the lamp body

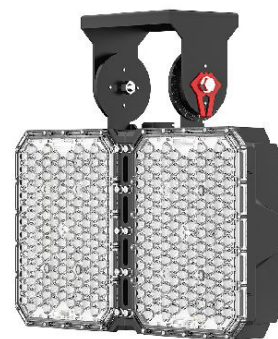

P4B -Trunnion + Separate remote installation

Packing Spec

Item	Box			Carton		
	Measurement(mm)	Gross weight	Pcs/box	Measurement(mm)	Gross weight	Pcs/box
FL400W~800W-07-G24-P1A	L645*W515*H300	19.00kg(41.89lbs)	1	/	/	/
FL400W~800W-07-G24-P2A/P3A/P4A	L595*W515*H300	20.00kg(44.09lbs)	1	/	/	/
FL400W~800W-07-G24-P1B	L645*W515*H250	14.00kg(30.86lbs)	1	/	/	/
FL400W~800W-07-G24-P2B/P3B/P4B	L595*W515*H250	15.00kg(33.07lbs)	1	/	/	/

Installation and use

Remarks	<p>Brown/Black – L Blue/White – N G/Y – GND</p>		
		<p>Caution :Vertical installation is absolutely not permitted.</p>	<p>Caution :When the angle of the luminous surface exceeds 90°, the lamp power is reduced by 20%.</p>

P1A/P1B Bracket

01	02	03	04								
	<p>M16x1pcs (Optional)</p>		<p>Driver AC cable Waterproof connector Electric supply AC power</p> <p>Safety Rope (Standard)</p>								
<table border="1"> <tr> <th>d1</th> <th>d2</th> <th>d3</th> <th>d4</th> </tr> <tr> <td>30mm</td> <td>200mm</td> <td>17mm</td> <td>17mm</td> </tr> </table>	d1	d2	d3	d4	30mm	200mm	17mm	17mm			
d1	d2	d3	d4								
30mm	200mm	17mm	17mm								

P2A/P2B Base

01	02	03	04						
	<p>M12x2pcs (Optional)</p>		<p>Driver AC cable Waterproof connector Electric supply AC power</p> <p>Safety Rope (Standard)</p>						
<table border="1"> <tr> <th>d1</th> <th>d2</th> <th>a1</th> </tr> <tr> <td>80mm</td> <td>13mm</td> <td>90°</td> </tr> </table>	d1	d2	a1	80mm	13mm	90°			
d1	d2	a1							
80mm	13mm	90°							

P3A/P2B Slip Fitter

01	02	03	04
<p>Suit for Ø50-63.5mm (Ø2.0-2.5")</p> <p>(Optional)</p>	<p>M10x2pcs (Standard)</p>		<p>Driver AC cable Waterproof connector Electric supply AC power</p> <p>Safety Rope (Standard)</p>
		<p>Caution: The angle between the installation part with the horizontal line must be greater than 0°.</p>	

P4A/P4B Trunnion

01	02	03	04								
	<p>M16x1pcs (Optional)</p>		<p>Electric supply AC power Waterproof connector Driver AC cable</p> <p>Safety Rope (Standard)</p>								
<table border="1"> <tr> <th>a</th> <th>d1</th> <th>d2</th> <th>d3</th> </tr> <tr> <td>120°</td> <td>80mm</td> <td>17mm</td> <td>13mm</td> </tr> </table>	a	d1	d2	d3	120°	80mm	17mm	13mm			
a	d1	d2	d3								
120°	80mm	17mm	13mm								