



VFL-07-G15 ROMAX LED Sports Light

Better solutions for ROMAX LED Sports Light

-  IP66 Water-proof
-  AC100-277V 50/60Hz
-  Easy Installation
-  120Lm/W 150Lm/W

Operating Temp.: -40°C~+50°C

Storage Temp. -40°C~+80°C



Options	Driver	Color	Beam Angle
	INVENTRONICS DRIVER	3000K 5000K 4000K 5700K	10° 60° 15° 90° 30° T2(117*34°)

Application

Sports Lighting, Stadium lighting, Sports fields, Car parks, High mast installations Dock, railway and container yards, Ports and other large scale outdoor applications, Architectural lighting, Landscape lighting, Industrial and commercial exterior lighting Decorative lighting for holidays, tradeshow, exhibitions.

Specifications

Item	Power	Effi.	Leds	CRI	Weight	Beam Angle
FL1200W-07-G15	1200W	120Lm/W 150Lm/W	SMD 3535 SMD 5050	>70	35.0kg(77.2lbs)	10°/15° 30°/60°/90°/T2(117*34°)
FL1500W-07-G15	1500W	120Lm/W 150Lm/W	SMD 3535 SMD 5050	>70	35.0kg(77.2lbs)	15° 30°/60°/90°/T2(117*34°)
FL1600W-07-G15	1600W	120Lm/W 150Lm/W	SMD 3535 SMD 5050	>70	35.0kg(77.2lbs)	15° 30°/60°/90°/T2(117*34°)
FL2400W-07-G15	2400W	120Lm/W 150Lm/W	SMD 3535 SMD 5050	>70	78.0kg(172.0lbs)	10°/15° 30°/60°/90°/T2(117*34°)
FL3000W-07-G15	3000W	120Lm/W 150Lm/W	SMD 3535 SMD 5050	>70	78.0kg(172.0lbs)	15° 30°/60°/90°/T2(117*34°)
FL3200W-07-G15	3200W	120Lm/W 150Lm/W	SMD 3535 SMD 5050	>70	78.0kg(172.0lbs)	15° 30°/60°/90°/T2(117*34°)
FL3600W-07-G15	3600W	120Lm/W 150Lm/W	SMD 3535 SMD 5050	>70	115.0kg(253.5lbs)	10°/15° 30°/60°/90°/T2(117*34°)
FL4500W-07-G15	4500W	120Lm/W 150Lm/W	SMD 3535 SMD 5050	>70	115.0kg(253.5lbs)	15° 30°/60°/90°/T2(117*34°)
FL4800W-07-G15	4800W	120Lm/W 150Lm/W	SMD 3535 SMD 5050	>70	115.0kg(253.5lbs)	15° 30°/60°/90°/T2(117*34°)



Dimensions(mm)

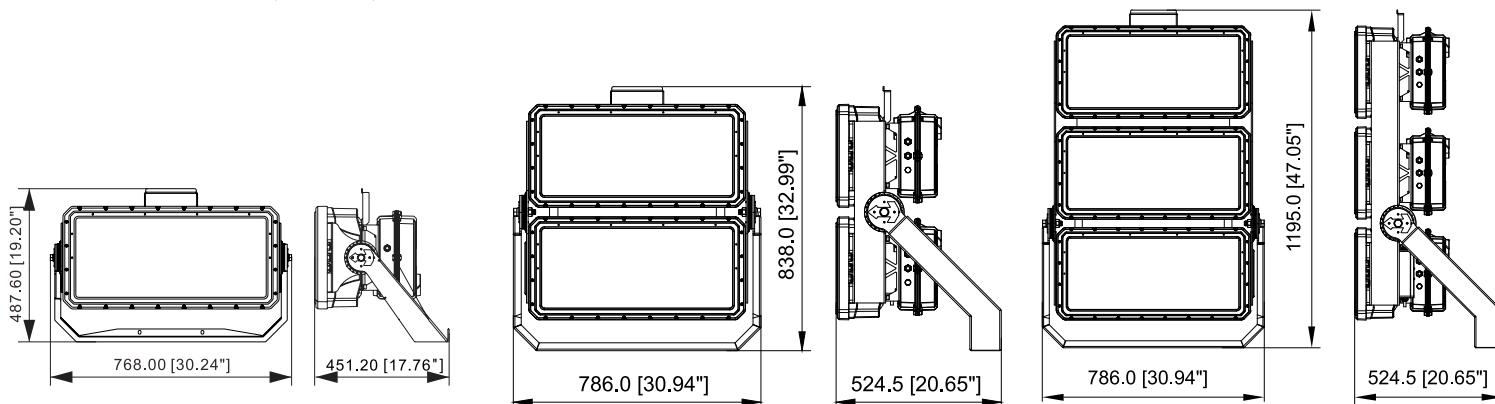

1200W/1500W/1600W-P1A

2400W/3000W/3200W-P1A

3600W/4500W/4800W-P1A

Photometry

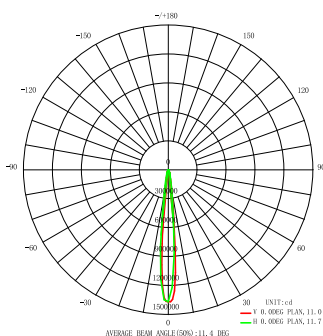

10°

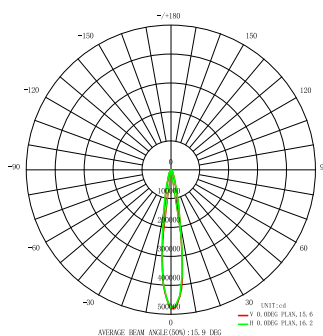

15°

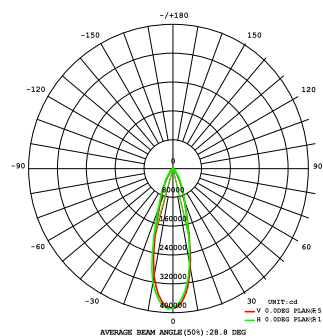

30°

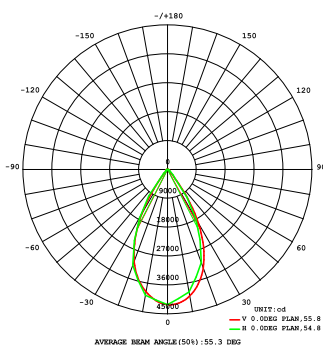

60°

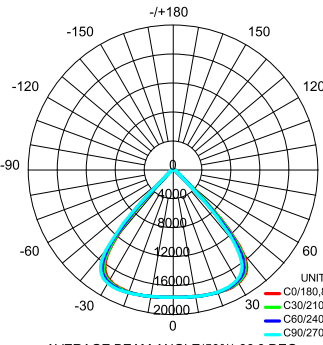

90°

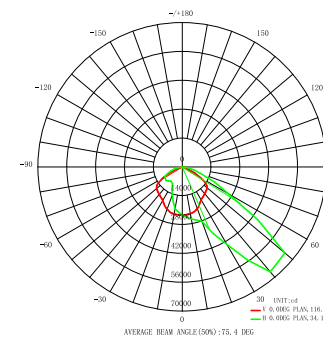

T2(117*34°)

Model Options



P1A -Bracket + Driver box mounted on the lamp body(Standard)



P1B -Bracket + Separate remote installation



P1C -Bracket + Driver box mounted on the bracket



P2A -Base + Driver box mounted on the lamp body(Standard)



P2B -Base + Separate remote installation



P2C -Base + Driver box mounted on the bracket



P3A -Slip fitter + Driver box mounted on the lamp body(Standard)



P3B -Slip fitter + Separate remote installation



Installation and use

Remarks	<p>Brown/Black – L Blue/White – N G/Y – GND</p>			
	Caution :Vertical installation is absolutely not permitted.		Caution :When the angle of the luminous surface exceeds 90 the lamp power is reduced by 20%.	

P1A/P1B/P1C Yoke

01 	02-Only P1A 	02-Only P1C 	03 	04
05 	06 Loosen the M12 hexagon socket screws on both sides of the bracket, then can adjust the angle as shown in the figure.		07 	08

Power	d1	d2	d3	d4	a
1200W-1600W	350mm	50mm	120mm	17mm	60°
2400W-4800W	450mm	50mm	120mm	17mm	49°

For more information request,welcome to contact us.

Packing Spec

Item	Box			Carton		
	Measurement(mm)	Gross weight	Pcs/box	Measurement(mm)	Gross weight	Pcs/box
FL1200W/1500W/1600W-07-G15-P1A/P2A/P3A	L840*W705*H425	40.0kg(88.2lbs)	1	/	/	/
FL1200W/1500W/1600W-07-G15-P1B/P2B/P3B	L840*W710*H270	27.0kg(59.5lbs)	1	/	/	/
FL1200W/1500W/1600W-07-G15-P1C/P2C	Lamp:L840*W710*H270	27.0kg(59.5lbs)	1	/	/	/
	G8 Driver Box: L500*W410*H260	12.5kg(27.6lbs)	1	/	/	/
FL2400W/3000W/3200W-07-G15-P1A	L1110*W910*H460	94.0kg(207lbs)	1	/	/	/
FL3600W/4500W/4800W-07-G15-P1A	L1470*W910*H460	130.0kg(287lbs)	1	/	/	/