



T BAR LIGHTING SYSTEM

T Bar Lighting is a new lighting fixture which was integrated to existing ceiling system. It can be placed in the ceiling wherever light is needed and leaves the ceiling unoccupied.

This way of lighting creates a minimalistic, elegant and modern aesthetic. Help designers elevate their project from ordinary to extraordinary.

3 configurations, 2FT, 4FT and 2L4T allow to build different light pattern like square, rectangular and other geometric layout.

T Bar Lighting System comes with a universal voltage REMOTE J-BOX for power supply. Tunable white solution is optional which maximizes the benefits of circadian lighting for enhanced health comfort, and productivity.

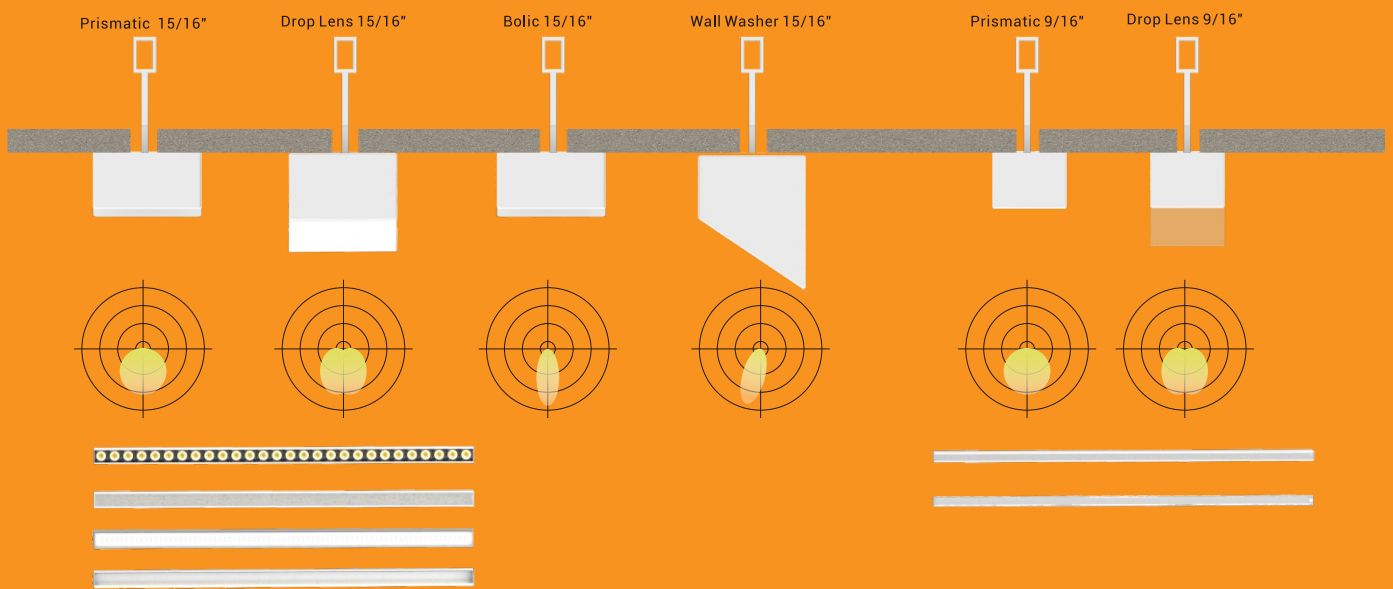
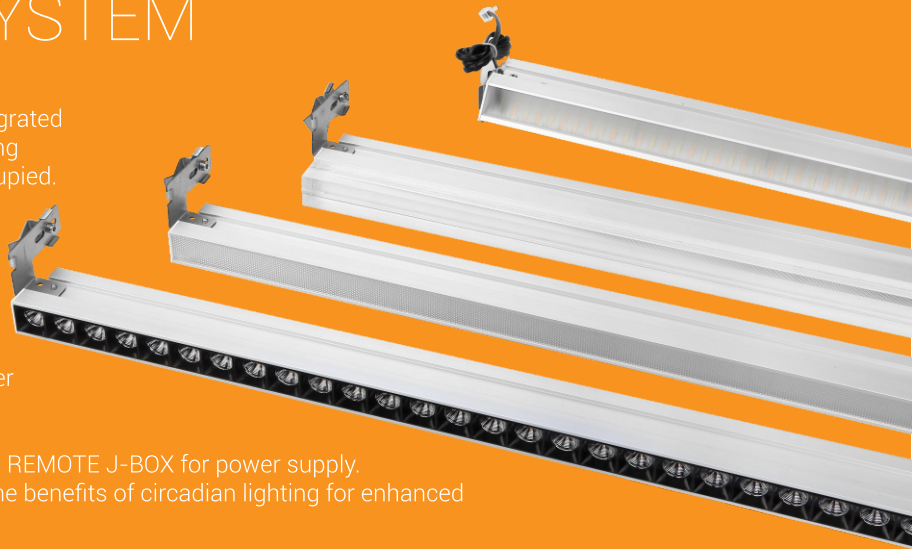

OPTIC OPTIONS

T Bar Lights come with 4 lens which offered different optic options to fit any applications.

Prismatic: High transmitting prismatic lens is for direct lighting, suitable for office, hospitality and school.

Drop Lens: This acrylic block lens is designed for special decorative use.

Bolic: The reflectors over each LED can concentrate the lights which is perfect for task area.

Wall Washer: This asymmetric lens was used for wall illumination.





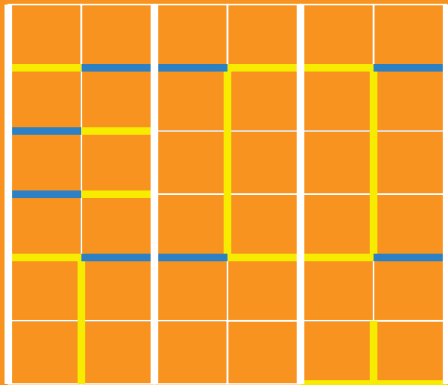

T BAR LIGHTING SYSTEM



INSTALLATION PATTERN

The T Bar Linear Lights can be mounted exactly where it needed, this flexibility allows to build unique ceiling grid layout like square or rectangular.

-  T Bar lights
-  2L4T model (half light and half exposed grid flange)
-  Cross Tee
-  One-piece main runner

REMOTE J-BOX

T Bar Light System offered a remote driver box for power supply which makes the installation and wiring super easy.

There are 2 different drivers available, one is for 0-10V dimming and another one is for 0-10V dimming & 0-10V white tuning.

Each Remote J-Box has a JB compartment for AC input direct wiring with metal conduit.

There are 2 or 4 ports RJ11 receptacle for T Bar lights power supply wiring. And another 2 ports RJ45 receptacle on the other side are for daisy chains the dimming and tuning signal.

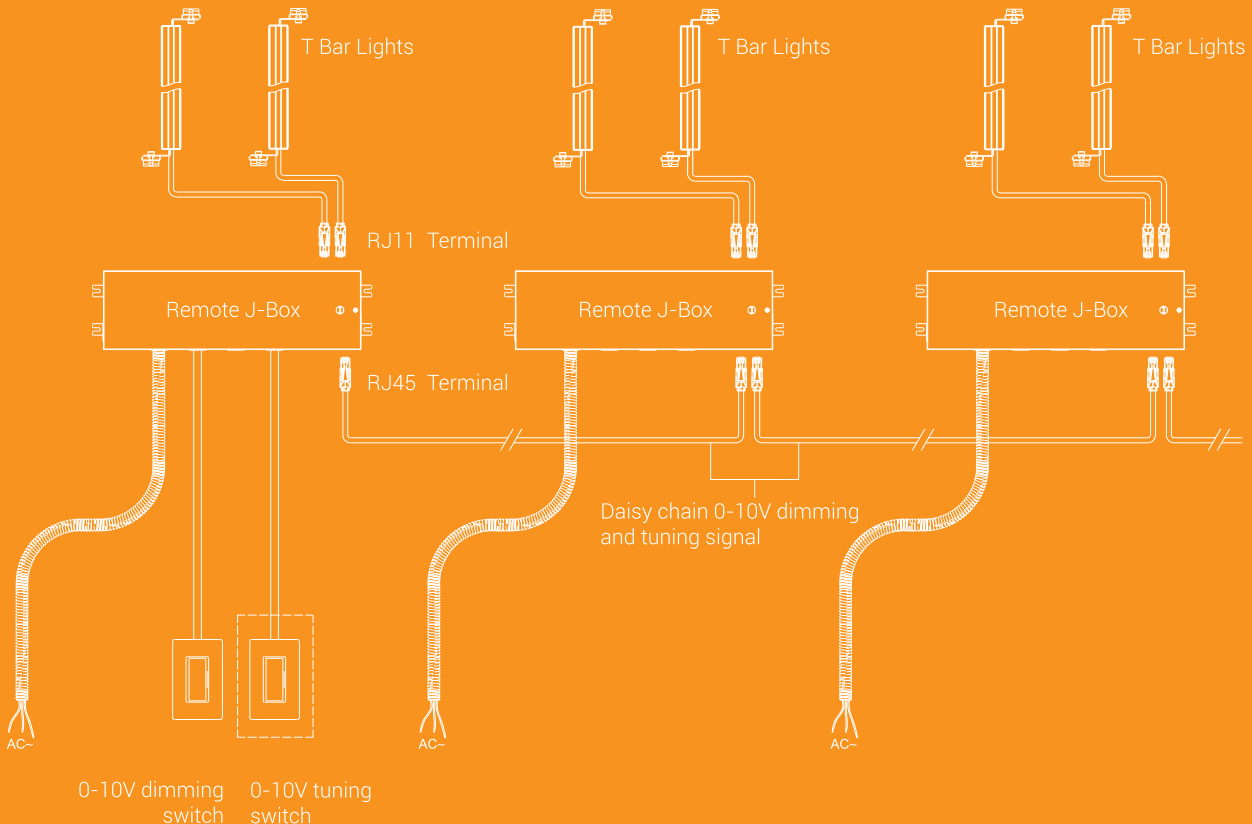
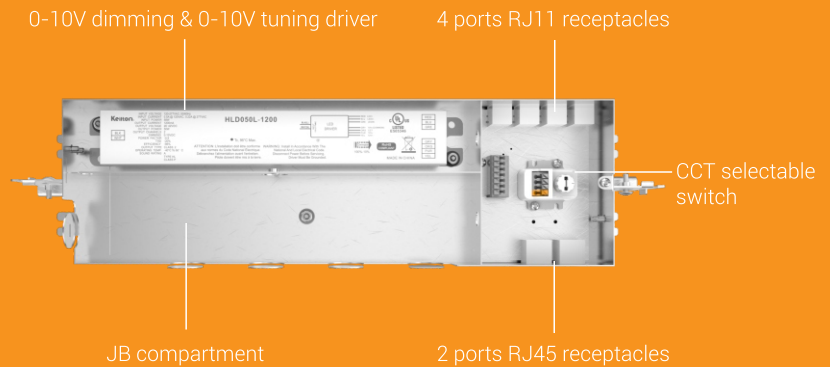

T-Linear™

T BAR LIGHTING SYSTEM THE LEVEL

PRODUCT FEATURES

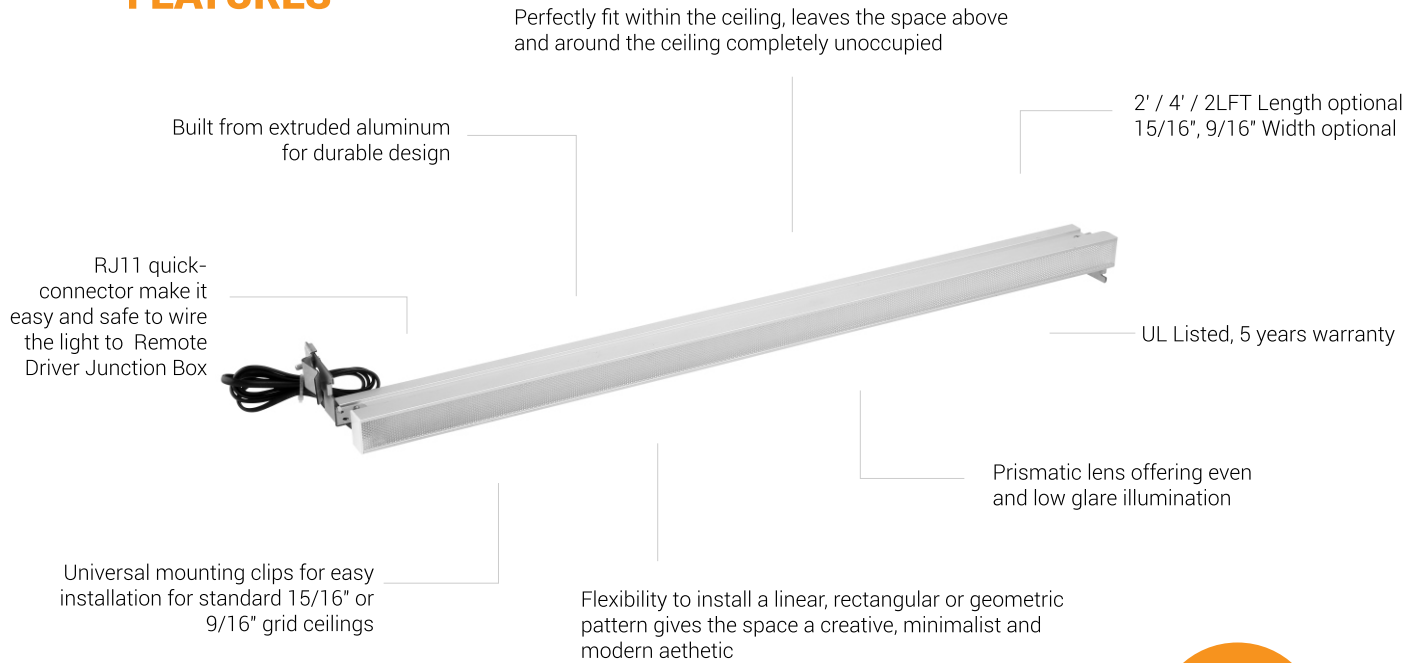

OUTPUT

2'	Single Static CCT - 1400LM, 700LM/FT, 100LPW White Tuning - 1200LM, 600LM/FT, 93LPW
4'	Single Static CCT - 2300LM, 575LM/FT, 100LPW White Tuning - 2200LM, 550LM/FT, 91LPW
2L4T	Single Static CCT - 1400LM, 700LM/FT, 100LPW White Tuning - 1200LM, 600LM/FT, 93LPW



APPLICATION

Commercial office spaces, Creative spaces, Open spaces, Retail, Classrooms, Corridors, Hospitality, Hotels, Industrial and public spaces.

ORDER NUMBER

Sample Part Number: **LVL-2-35-1516-N**

SERIES		LENGTH		COLOR TEMP		GRID		CRI		MOUNTING	
LVL	Level Series	2	2'(15W)	35	3500K	1516	15/16" Grid	C	>90	R	Retrofitting
		4	4'(25W)	40	4000K	916	9/16" Grid	Blank	>80	N	New Construction
		2L4T	2' LED 4' Tee (15W)	CCT	White Tuning						

LINE DRAWING

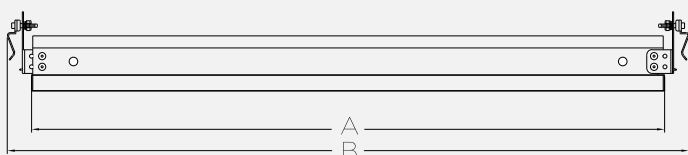

	A	B
2ft	23.07"	25.12"
4ft	47.00"	49.06"

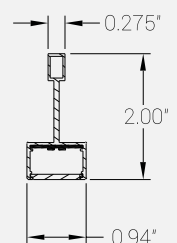
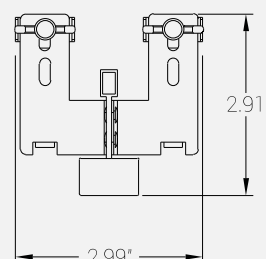

T-Linear™

T BAR LIGHTING SYSTEM LEVEL BOLIC

PRODUCT FEATURES

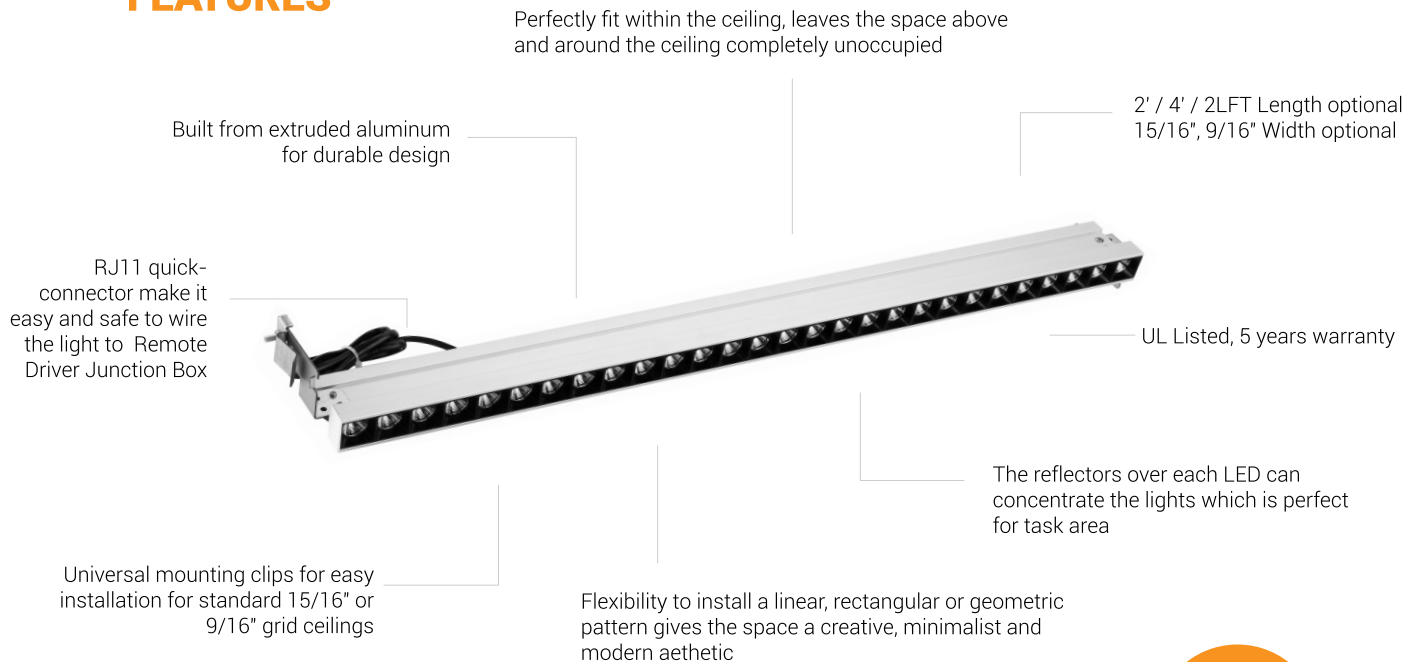

OUTPUT

2'	Single Static CCT - 1200LM, 600LM/FT, 77LPW White Tuning - 1100LM, 550LM/FT, 70LPW
4'	Single Static CCT - TBD White Tuning - TBD
2L4T	Single Static CCT - TBD White Tuning - TBD



APPLICATION

Commercial office spaces, Creative spaces, Open spaces, Retail, Classrooms, Corridors, Hospitality, Hotels, Industrial and public spaces.

ORDER NUMBER

Sample Part Number: **LVLBC-2-35-1516-N**

SERIES	LENGTH	COLOR TEMP	GRID	CRI	MOUNTING
LVLBC Level Bolic Series	2	35	1516	C	R N Retrofitting New Construction
	4	40	916	Blank	
	2L4T*	CCT		>90 >80	
	2'(15W)	3500K	15/16" Grid		
	4'(25W)	4000K	9/16" Grid		
	2' LED 4'Tee (15W)	White Tuning			

*2L4T models only have 15/16" Grid.

LINE DRAWING

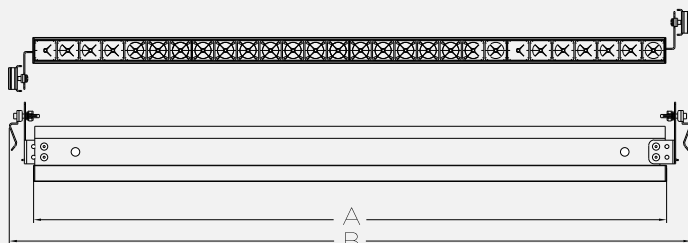

	A	B
2ft	23.07"	25.12"
4ft	47.00"	49.06"

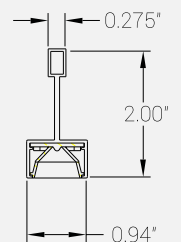
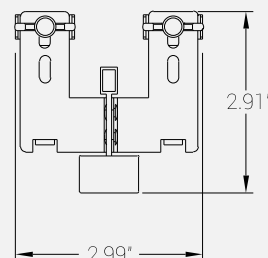

T-Linear™

T BAR LIGHTING SYSTEM LEVEL DROP LENS

PRODUCT FEATURES

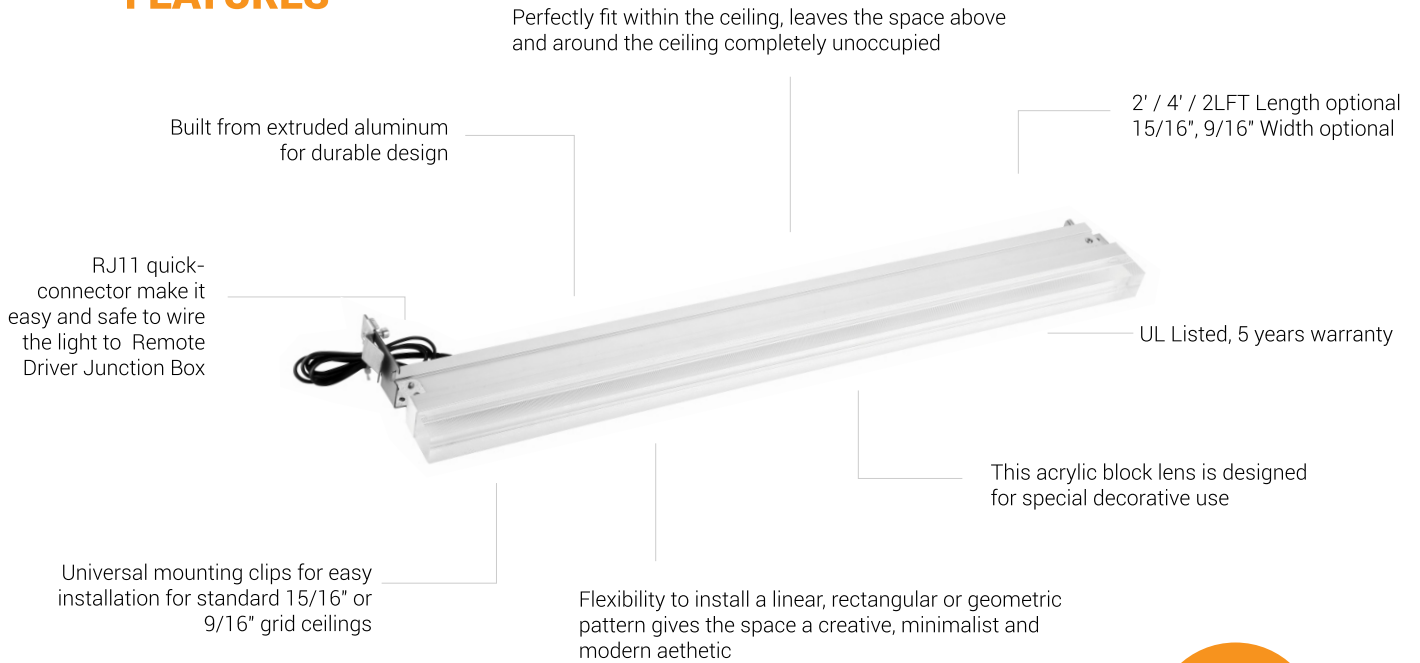

OUTPUT

2'	Single Static CCT - 1000LM, 500LM/FT, 80LPW White Tuning - 950LM, 475LM/FT, 70LPW
4'	Single Static CCT - TBD White Tuning - TBD
2L4T	Single Static CCT - TBD White Tuning - TBD



APPLICATION

Commercial office spaces, Creative spaces, Open spaces, Retail, Classrooms, Corridors, Hospitality, Hotels, Industrial and public spaces.

ORDER NUMBER

Sample Part Number: **LVLDP-2-35-1516-N**

SERIES		LENGTH		COLOR TEMP		GRID		CRI		MOUNTING	
LVLDP	Level Drop Lens Series	2	2'(15W)	35	3500K	1516	15/16" Grid	C	>90	R	Retrofitting New Construction
		4	4' (25W)	40	4000K	916	9/16" Grid	Blank	>80		
		2L4T	2' LED 4' Tee (15W)	CCT	White Tuning						

LINE DRAWING



	A	B
2ft	23.07"	25.12"
4ft	47.00"	49.06"

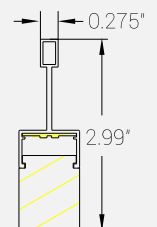
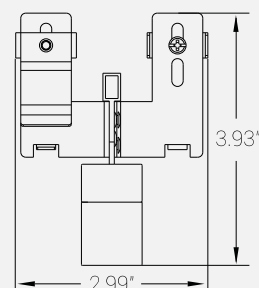

T-Linear™

T BAR LIGHTING SYSTEM LEVEL WW

PRODUCT FEATURES

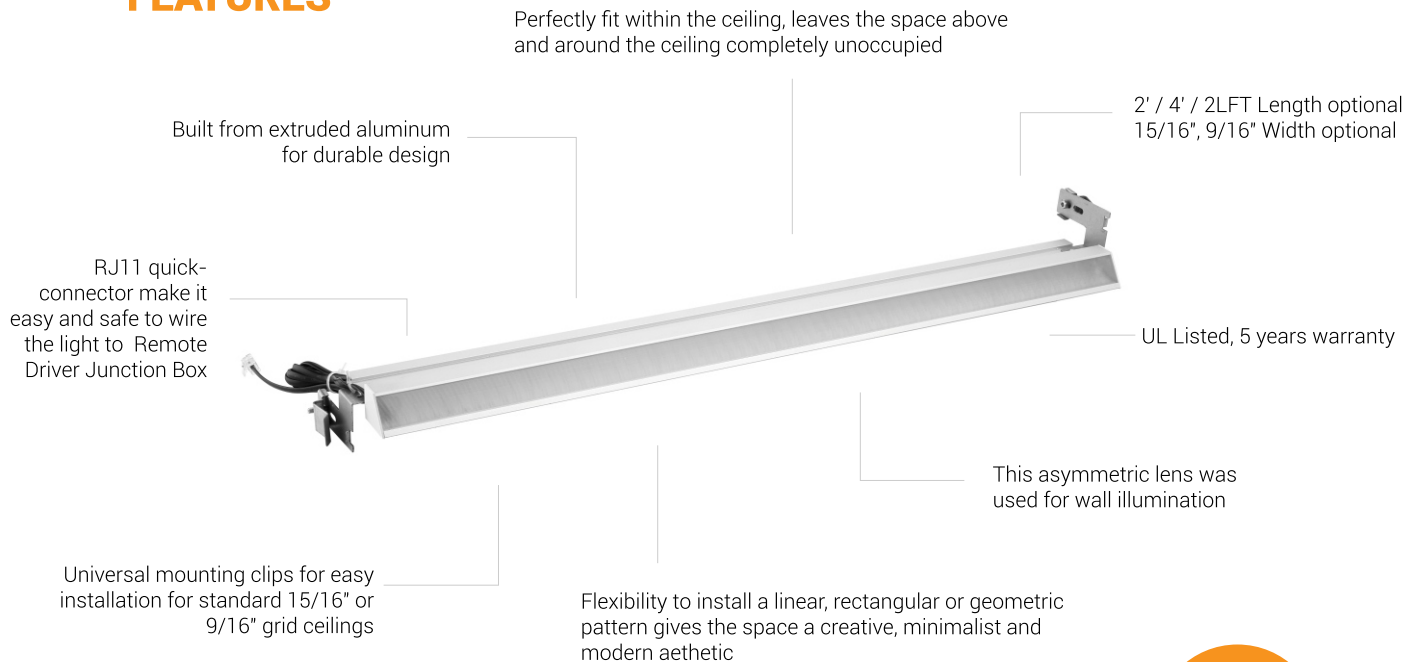

OUTPUT

2'	Single Static CCT - 800LM, 400LM/FT, 60LPW White Tuning - 800LM, 400LM/FT, 58LPW
4'	Single Static CCT - TBD White Tuning - TBD
2L4T	Single Static CCT - TBD White Tuning - TBD



APPLICATION

Commercial office spaces, Creative spaces, Open spaces, Retail, Classrooms, Corridors, Hospitality, Hotels, Industrial and public spaces.

ORDER NUMBER

Sample Part Number: **LVLWW-2-35-1516-N**

SERIES	LENGTH	COLOR TEMP	GRID	CRI	MOUNTING
LVLWW Level WW Series	2	35	1516	C Blank	R Retrofitting N New Construction
	4	40	916		
	2L4T*	CCT			
	2'(15W)	3500K	15/16' Grid	>90	
	4'(25W)	4000K	9/16' Grid	>80	
	2' LED 4' Tee (15W)	White Tuning			

*2L4T models only have 15/16' Grid.

LINE DRAWING

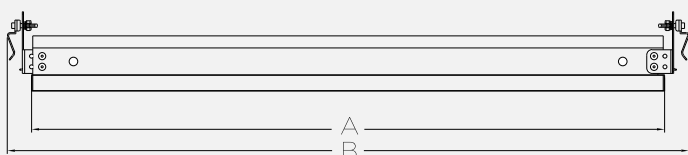

	A	B
2ft	23.07"	25.12"
4ft	47.00"	49.06"

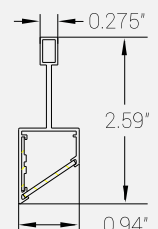
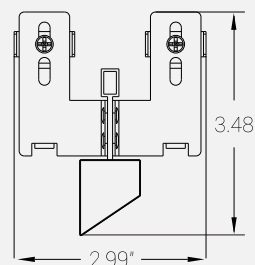

T-Linear™

T BAR LIGHTING SYSTEM REMOTE J-BOX

PRODUCT FEATURES

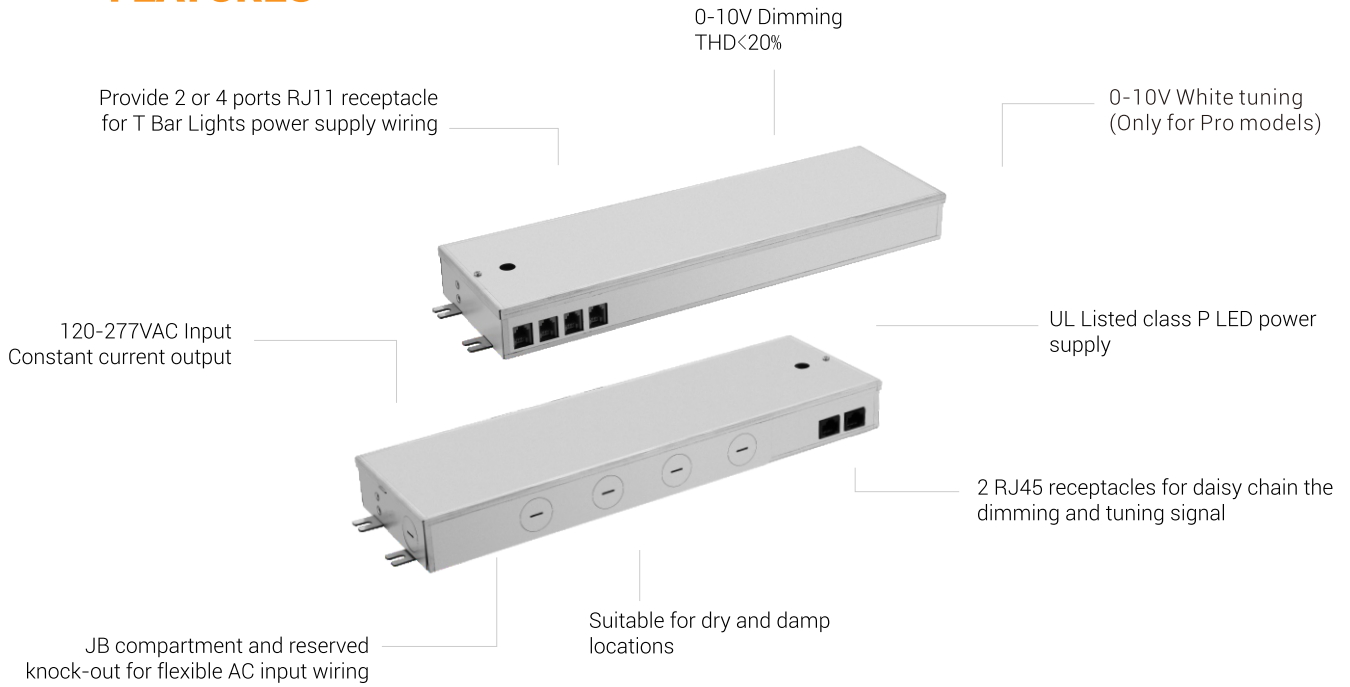

ORDER NUMBER

MODEL NUMBER	POWER CONSUMPTION	INPUT VOLTAGE	OUTPUT VOLTAGE	OUTPUT CURRENT	RJ11 PORT	RJ45 PORT	POWERED T BAR QTY	DIMMING	TUNING
TG-HLD050L-1200	65W	120-277V AC	20-45V	600mA/Port	2	2	2x4'	0-10V	0-10V
TG-HLD030-700	35W	120-277V AC	20-45V	350mA/Port	2	2	2x2'	0-10V	0-10V
TG-HLS060-1200-2	65W	120-277V AC	30-50V	600mA/Port	2	2	2x4'	0-10V	N/A
TG-HLS060-1200-4	65W	120-277V AC	30-50V	300mA/Port	4	2	4x2'	0-10V	N/A

LINE DRAWING

